

Large Projects

Hotel, Wellness & more

ezarri

ezarri

Mosaic Devotees

Recycled glass mosaic
manufacturers,
since 1979

Index

05	About Ezarri
13	Services
27	Projects
63	Case Studies
95	Wellness

Dreams are made of mosaics

More than 40 years of experience working with large-scale projects around the world have earned Ezarri its place as a benchmark in **100% recycled glass mosaic**. Our expertise allows us to deliver bespoke design solutions with custom combinations, printed mosaics and corporate logos. We offer turnkey designs for **large projects and hotel chains**, creating everything from unique swimming pools to evocative wellness spaces.

Mosaics **made in Spain** featuring our patented **JointPoint®** system.

Más de 40 años de experiencia en proyectos internacionales de gran envergadura nos han convertido en referentes del **mosaico de vidrio 100% reciclado**. Esta experiencia nos permite personalizar cada proyecto con mezclas a medida, mosaicos impresos y/o diseños corporativos. Ofrecemos soluciones completas para **grandes proyectos y cadenas hoteleras**, creando desde piscinas únicas hasta evocadores espacios wellness.

Mosaicos **made in Spain**, con nuestro sistema patentado **JointPoint®**.

Plus de 40 ans d'expérience dans des projets internationaux de grande envergure nous ont permis de devenir des référents en **mosaïque de verre 100% recyclé**. Cette expérience nous permet de personnaliser chaque projet avec des mélanges personnalisés, des mosaïques dessins imprimés et/ou corporatifs. Nous offrons des solutions complètes pour les **grands projets et les chaînes hôtelières**, en créant des piscines uniques et même des espaces évocateurs Bien-être.

Mosaïques **made in Espagne**, avec notre système breveté **JointPoint®**.



(ENG)

Dedicated entirely to glass mosaic, **our technical expertise and manufacturing capabilities** allow us to create innovative solutions inspired by avant-garde design and produced to the **highest quality and standards.**

Our recycled glass mosaic tile is manufactured entirely at our facility in Lazkao, Spain. This allows us to be extremely demanding when it comes to achieving the best results, and totally **flexible in meeting our customers' needs.** Our unwavering commitment to design, together with our approach to technology and production, has positioned us as a **world leader in glass mosaic tile.**

(ESP)

Nuestro **expertise técnico y productivo**, totalmente especializado en el mosaico de vidrio, nos permite crear soluciones innovadoras inspiradas en la vanguardia y el diseño, y producidas con la máxima **calidad y exigencia.**

Fabricamos el 100% de nuestro producto a partir de vidrio reciclado y lo hacemos en nuestras instalaciones de Lazkao (España). Eso nos permite ser extremadamente rigurosos con el resultado final de nuestras soluciones además de absolutamente **flexibles con las necesidades de nuestros clientes.** Nuestra continua apuesta por el diseño, sumada a nuestro enfoque productivo/tecnológico, nos han posicionado como **referentes del mosaico de vidrio a nivel mundial.**

(FRA)

Notre **expertise technique et productive**, totalement spécialisée dans la mosaïque de verre, nous permet de créer des solutions innovatrices inspirées de l'avant-garde et du design, et produites avec la **qualité maximale et de l'exigence.**

Nous fabriquons 100% de notre produit à partir de verre recyclé et nous le faisons dans nos installations de Lazkao (Espagne), cela nous permet d'être extrêmement rigoureux avec le résultat final de nos solutions mais aussi absolument **flexibles avec les besoins de nos clients.** Notre pari continu pour le design, ajouté à notre vision productive/technologique, ont fait de nous une **référence de la mosaïque de verre à niveau mondial.**

More than experience

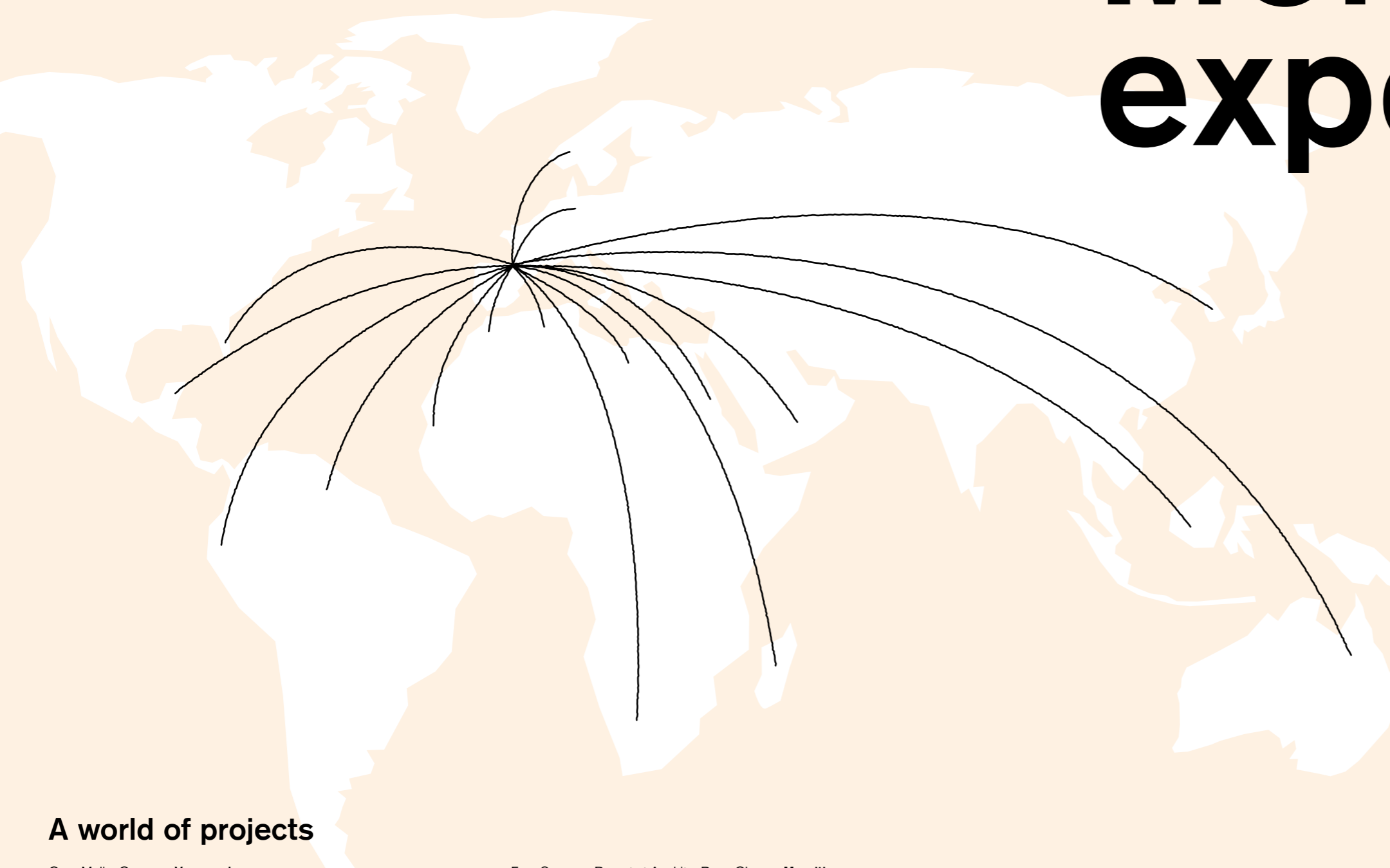

When it comes to **large-scale projects**, **experience is key**. Suppliers must be able to meet the demands while providing confidence and reliability.

At **Ezarri**, proof of our quality and workmanship lies in the **hundreds of projects** we have executed internationally. **Wellness centres and major hotel chains** around the world boast luxurious spaces and wellness areas created with **Ezarri** mosaic tiles.

A world of projects

Gran Meliá, Caracas, **Venezuela**
 Sheraton Algarve, Albufeira, **Portugal**
 Bio hotel organic suites, Bogotá, **Colombia**
 Hotel Grand Palladium Jamaica, Lucea, **Jamaica**
 J.W. Guanacaste Resort & Spa, **Costa Rica**
 Centre Thalasso Serge Blanco, Hendaye, **France**
 Club Golf Hotel, Montevideo, **Uruguay**
 Nhow Berlin, Berlin, **Germany**
 Hotel Trois Rocs, Verbier, **Switzerland**
 Hard Rock, Ibiza, **Spain**
 Marmari Palace Hotel, Kos, **Greece**
 Hotel Sousse Palace, Sousse, **Tunisia**
 Izvor arandjelovac, Arandjelovac, **Serbia**
 Ballykisteen Hotel And Golf Resort, Tipperary, **Ireland**
 Furnas Boutique Hotel Thermal & Spa, Furnas, **Azores (Portugal)**
 Iberostar Grand Hotel Antheia, Tenerife, **Spain**
 Sofitel Marseille Vieux Port, Marseille, **France**
 Regent Hotel (porto montenegro), Tivat, **Montenegro**
 Hotel Barceló Punta Umbria, Punta Umbria, **Spain**
 The view Boutique Spa, Amanzimtoti, **South Africa**
 Al Salam Rotana, Khartoum, **Sudan**
 Goldem Tulip Tangier, Tangier, **Morocco**

Four Seasons Resort at Anahita, Beau Champ, **Mauritius**
 Grand Complexe Touba Almadies, Dakar, **Senegal**
 Sofitel Rabat, Rabat, **Morocco**
 La Cigale Tabarka Hotel, Tabarka, **Tunisia**
 Movempick Manama, Manama, **Barhain**
 Anantara Desert Islands, Abu Dhabi, **United Arab Emirates**
 Hotel Sasccharum Marina Spa, Calheta, **Madeira (Portugal)**
 Hotel Movich, Barranquilla, **Colombia**
 Mandarin Oriental, Hong Kong, **China**
 Marina 101, Dubai, **United Arab Emirates**
 Swiss Belhotel Bintam, Lagoi, **Indonesia**
 Turf Club, Singapore, **Singapore**
 Kempinski Batumi, Batumi, **Georgia**
 Shangri-La's Barr Al Jissah Resort & Spa, Muscat, **Oman**
 Ishaam Clubs and Hotels, Udaipur, **India**
 Riu Green Park, Sousse, **Tunisia**
 Bora Bora Lagoon Resort, Bora Bora, **French Polynesia**
 NH Collection Madrid Eurobuilding, Madrid, **Spain**
 Los Sueños Marriott Resort, Herradura, **Costa Rica**
 Park Hyatt Hotel, Sydney, **Australia**

Quando hablamos de **grandes proyectos**, **la experiencia es un grado** y los proveedores deben estar al nivel de las exigencias, aportando confianza y seguridad.

En **Ezarri**, nuestro mejor aval son los **cientos de proyectos** realizados a nivel internacional: **Centros Wellness y Hoteles de grandes cadenas** alrededor de todo el mundo, en los que se han creado espacios de lujo y áreas de bienestar en las que lucen los mosaicos **Ezarri**.

Quand nous parlons de **grands projets**, **l'expérience est une qualité** et les fournisseurs doivent répondre à nos exigences, en apportant de la confiance et de la sécurité.

À **Ezarri**, notre meilleure garantie sont les **centaines de projets** réalisés à niveau international: **Centres de bien-être et Hôtels de grandes chaînes** dans le monde entier, où des espaces de luxe ont été créés et des espaces de bien-être dans lesquels brillent les mosaïques **Ezarri**.

More than services

1

Product Selection

The mosaic best suited to your project.

El mosaico que mejor se adapta a tu proyecto.

La mosaïque qui s'adapte le mieux à votre projet.

2

Custom mosaics

Full mosaic customisation.

Personalización completa del mosaico.

Personnalisation complète de la mosaïque.

3

Design proposals

We'll help design your space and provide advice based on client specifications.

Diseñamos y sugerimos el espacio según criterio del cliente.

Nous concevons et nous suggérons l'espace selon les critères du client.

4

Technical Documents

Drawings for installation and assembly of mosaic tile.

Planos de instalación y montaje de mosaico.

Plans d'installation et assemblage de mosaïque.

5

Finishing System

The correct installation guarantee.

La garantía de una correcta instalación.

La garantie d'une installation correcte.

6

Online / Onsite Support

Technical consulting service and installation training.

Servicio de asesoría técnica y academia de instalación.

Service de conseil technique et académie d'installation.

Product Selection

The mosaic best suited to your project

El mosaico que mejor se adapta a tu proyecto

La mosaïque qui s'adapte le mieux à votre projet



Samples

We'll provide product samples anywhere in the world.

Proveemos muestras de producto a cualquier parte del mundo

Nous fournissons des échantillons de produits partout dans le monde.



Colour & Collection

Choose from over 300 colours and 14 Ezarri collections.

Elige entre los más de 300 colores y sus 14 colecciones de Ezarri.

Choisissez parmi plus de 300 couleurs et 14 collections d'Ezarri.



Safe Steps & Special Pieces

Choose from a variety of finishes: anti-slip, smooth tiles and special pieces depending on use and surface type required.

Elige entre distintos acabados: antideslizantes, lisos y piezas especiales según necesidades de uso y superficie a instalar.

Choisissez parmi différentes finitions: antidérapants, pièces lisses et spéciales selon les besoins d'utilisation et de surface à installer.

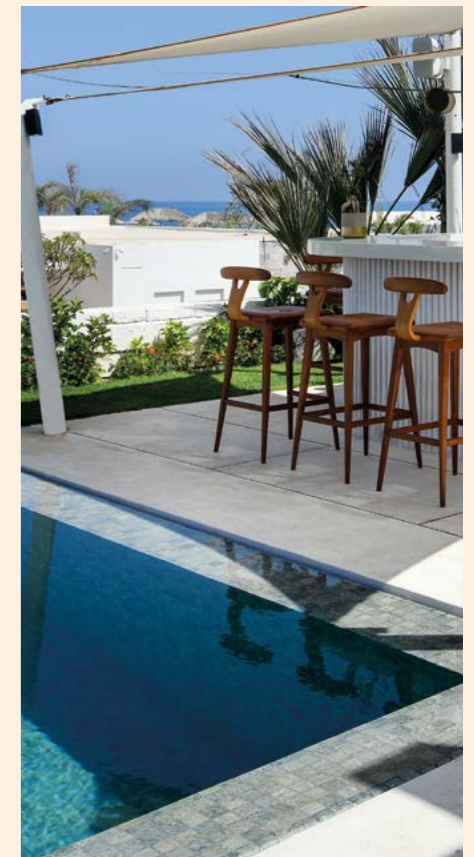

References

We'll send photographs and references to help you better visualise your project.

Enviamos fotografías y referencias para poder visualizar mejor lo que necesitas.

Nous envoyons des photographies et des références pour pouvoir visualiser au mieux ce dont vous avez besoin.

Custom Mosaics

Full mosaic customisation

Personalización completa del mosaico

Personnalisation complète de la mosaïque

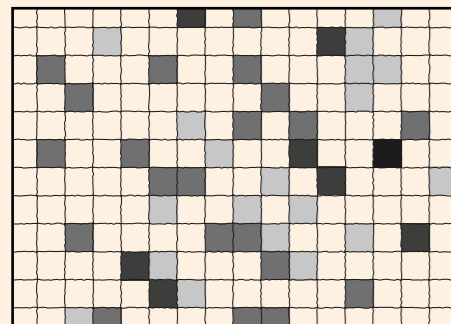

Custom Mix

Design your own mix: combine our tiles in whatever proportions you like.

Diseña tu propia mezcla: combina nuestras referencias en los porcentajes que quieras.

Concevez votre propre mélange : combinez nos références dans les pourcentages que vous souhaitez.

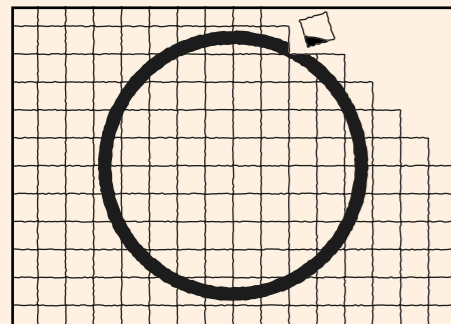

Custom Printed Mosaic

We can print any image, logo or illustration on mosaic tile.

Podemos imprimir en mosaico cualquier imagen, logo o ilustración.

Nous pouvons imprimer en mosaïque n'importe quelle image, logo ou illustration.

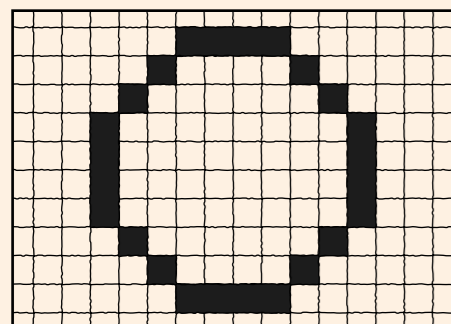

Custom Pixel Mosaic

We can create a customised design from an image in which each mosaic tile is a pixel.

Desde una imagen podemos crear una propuesta a medida donde cada ficha de mosaico es un píxel.

À partir d'une image, nous pouvons créer une proposition personnalisée où chaque pièce de mosaïque est un pixel.

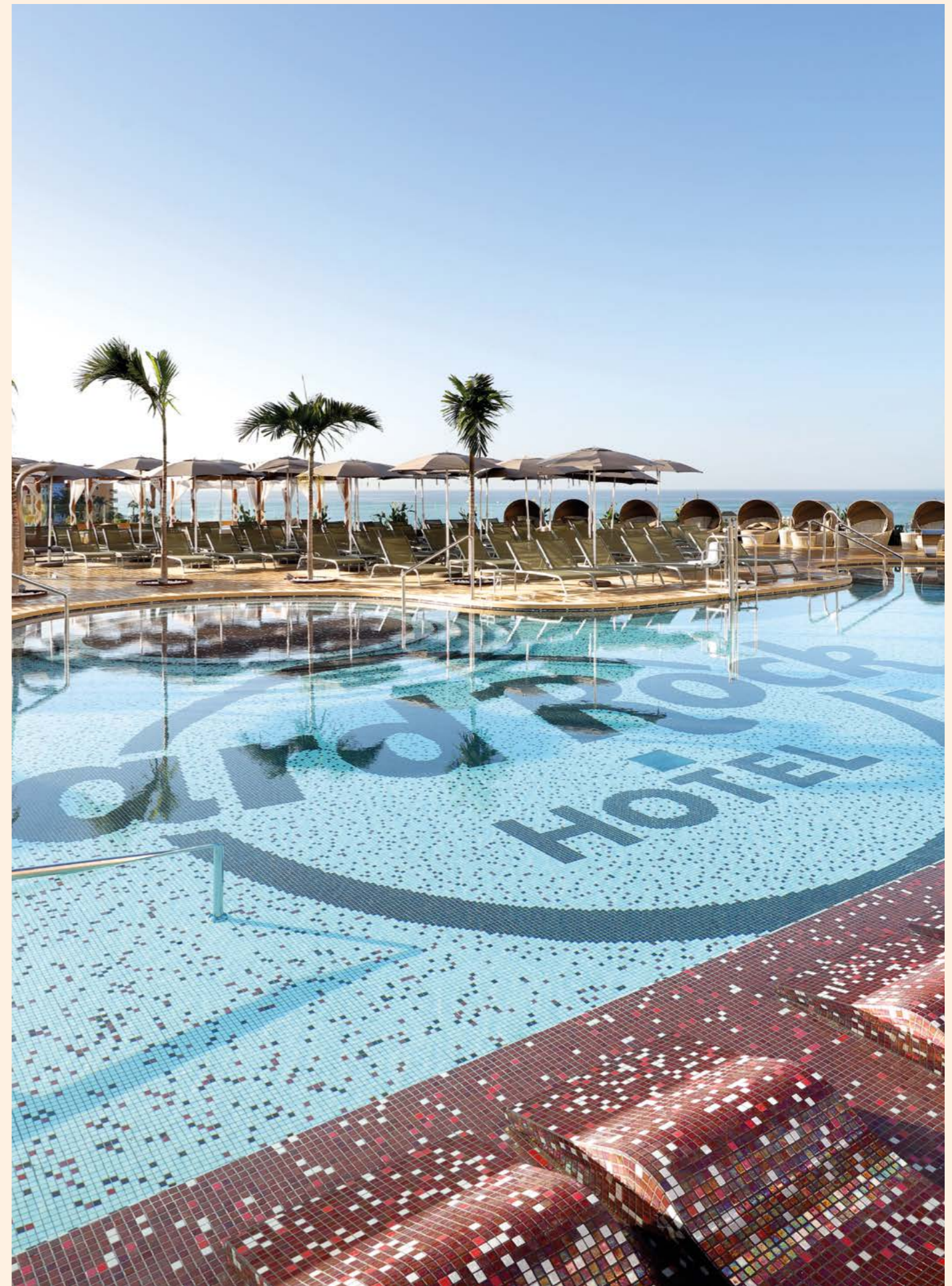

Logos and branding

Showcase your logo with a corporate mosaic.

Refuerza tu branding, plasmando tu logo sobre el mosaico.

Renforcez votre image de marque, en capturant votre logo sur la mosaïque.

Design Proposals

We'll help design your space and provide advice based on client specifications

Diseñamos y sugerimos el espacio según criterio del cliente

Nous concevons et nous suggérons l'espace selon les critères du client

3D Render

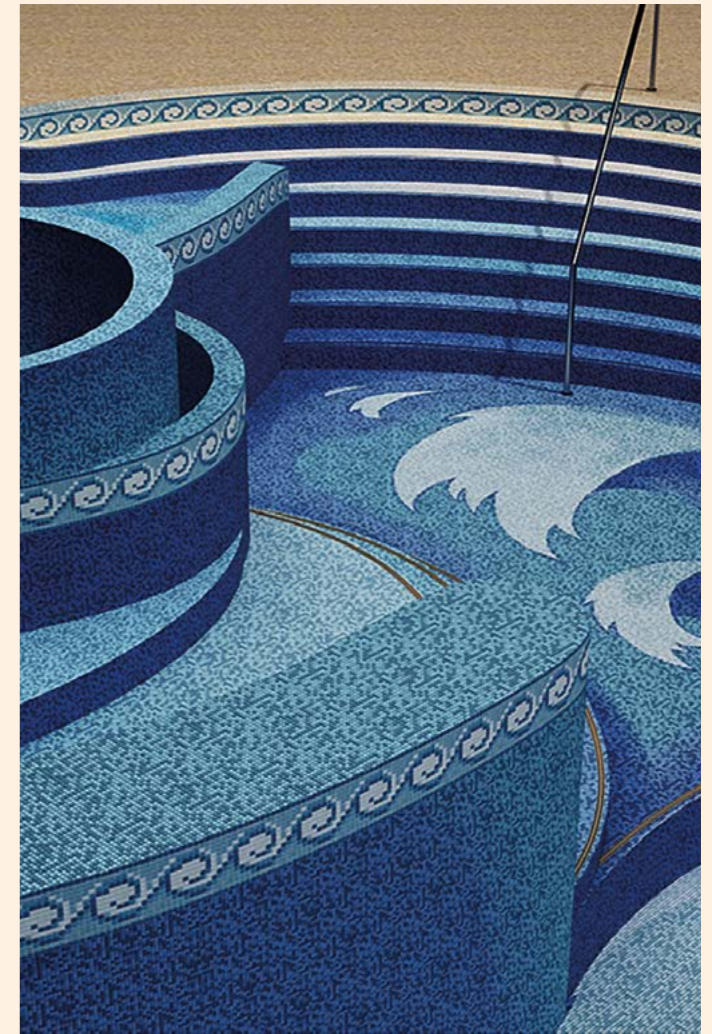

Design Concept Sketch

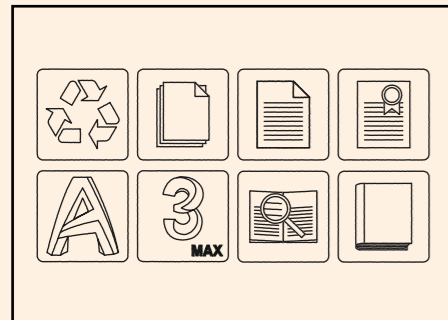
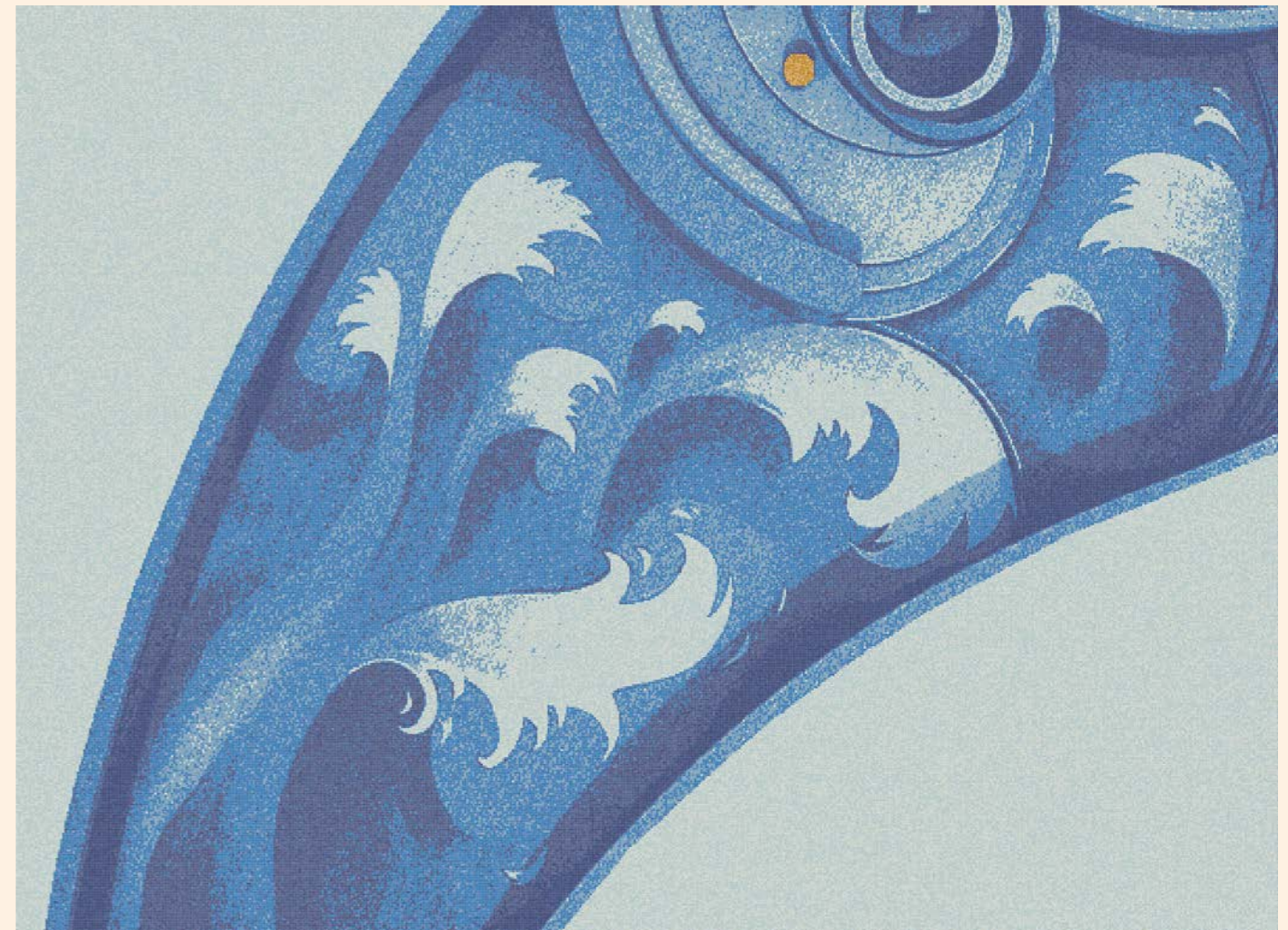

Design tools

Visit our website and download everything you need to know about textures, descriptive reports, certifications, technical data sheets, construction details and much more.

Accede a nuestra web y descarga texturas, memorias descriptivas, certificaciones, fichas técnicas, detalles constructivos y mucho más.

Accédez à notre site Web et téléchargez des textures, des rapports descriptifs, des certifications, des fiches techniques, des détails de construction et bien plus encore.

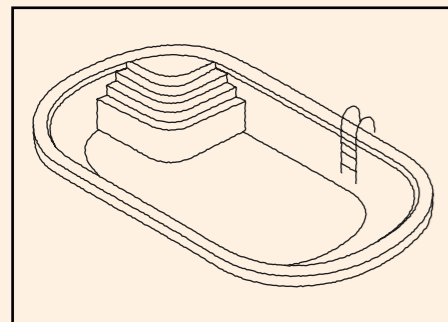

2D & 3D Renders

We'll generate 2D documentation and customised 3D previews adapted to your needs.

Generamos documentación 2D y previsualizaciones 3D personalizadas y adaptadas a tus necesidades.

Nous générons de la documentation 2D et des aperçus 3D personnalisés et adaptés à vos besoins.

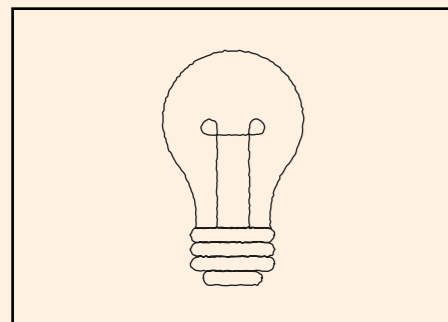

Custom proposal

We'll design and suggest alternatives to make the most of your project.

Diseñamos y proponemos alternativas adicionales para la mejora del proyecto.

Nous concevons et proposons des alternatives supplémentaires pour l'amélioration du projet.

Technical Documents

Drawings for installation and assembly of mosaic tile

Planos de instalación y montaje de mosaico

Plans d'installation et assemblage de mosaïque

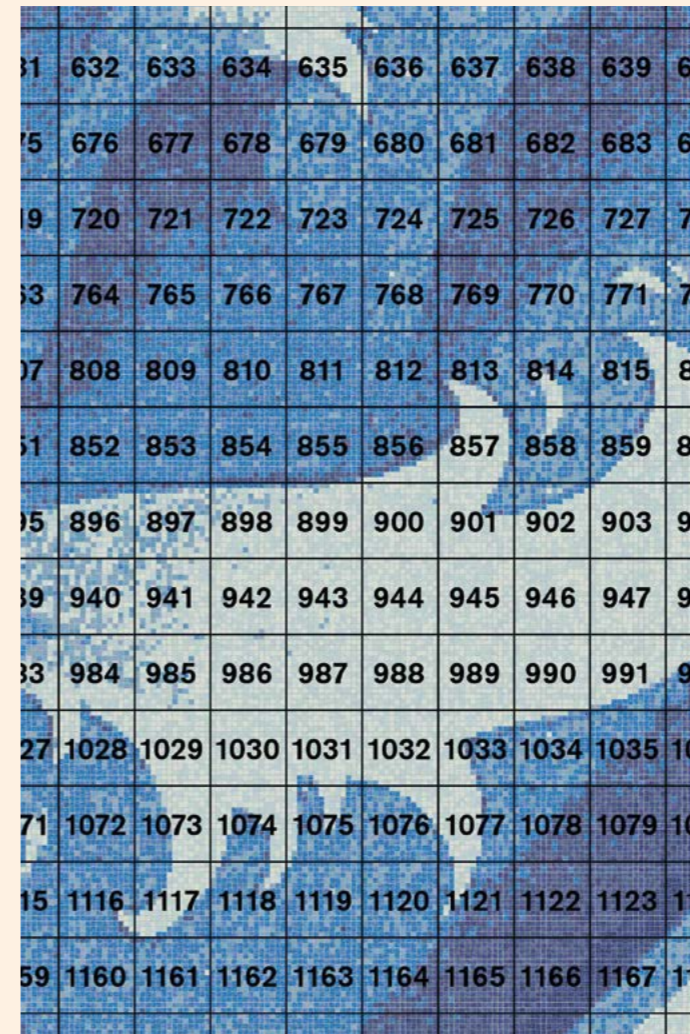

Mosaic Tiling Plans

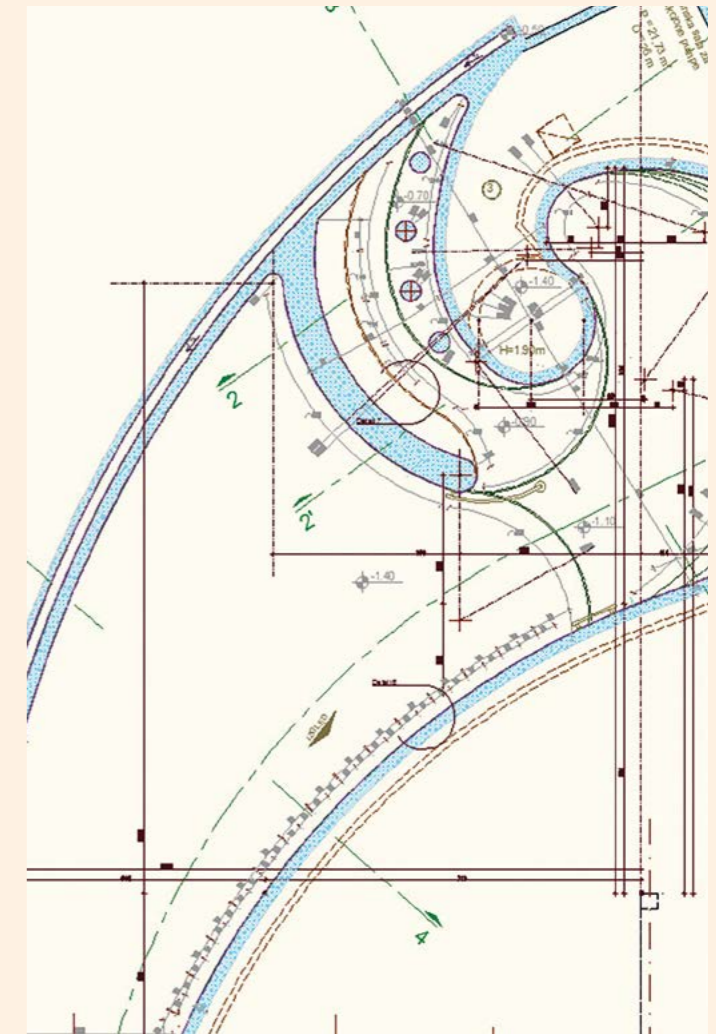

Special detailing

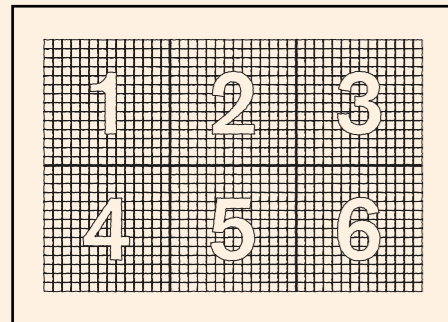

Mosaic Tiling Plans

We'll send ordered and numbered assembly drawings for each project.
 Enviamos planos de montaje ordenados y numerados de cada proyecto.
 Nous envoyons des plans d'assemblage ordonnés et numérotés de chaque projet.



Project Installation Plans

We'll provide drawings adapted to your project to ensure correct installation of the mosaic.
 Proveemos planos adaptados a tu proyecto para asegurar la correcta instalación del mosaico.
 Nous fournissons des plans adaptés à votre projet pour s'assurer de la bonne installation de la mosaïque.

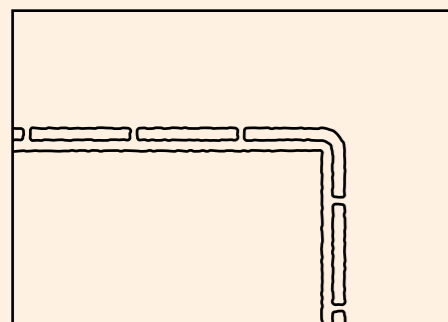

Special detailing

We'll help you with details on jointing, corner installation and irregular points and shapes for your project.
 Te ayudamos con los detalles de encuentros y puntos singulares del proyecto.
 Nous vous aidons avec les détails des rencontres et des points singuliers du projet.

Finishing System

The correct installation guarantee

La garantía de una correcta instalación

La garantie d'une installation correcte



Warranty on Mosaics

Ezarri guarantees that its glass mosaics are free from manufacturing defects. Terms and conditions at Ezarri.com.

Ezarri, garantiza al comprador que sus mosaicos de vidrio están libres de defectos de fabricación. Términos y condiciones en Ezarri.com.

Ezarri, garantit à l'acheteur que ses mosaïques de verre sont exemptes de défauts de fabrication. Termes et conditions sur Ezarri.com.

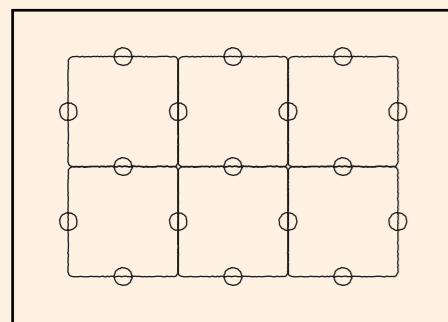

JointPoint®

The panelling system is the most important factor in the quality of the mosaic.

El sistema de empanelado es el factor más importante y de mayor influencia en la calidad del mosaico.

Le système de fixation est le facteur le plus important et ayant la plus grande influence sur la qualité de la mosaïque.

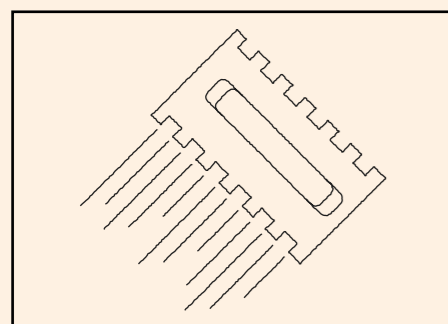

Adhesives&Joints

The right installation products are essential, preferably from the same manufacturer.

Los productos de instalación deben ser los adecuados, preferiblemente de un mismo fabricante.

Les produits d'installation doivent être les corrects, de préférence du même fabricant.

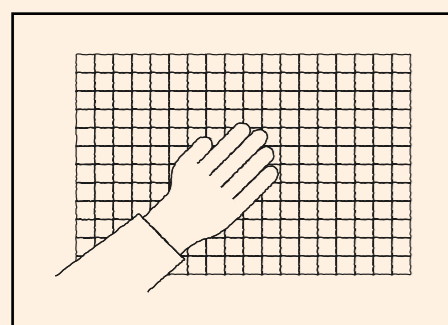

Specialised workforce

A professional installer, using Ezarri mosaic and the right installation products will ensure a successful long-lasting project.

Un instalador profesional, que utilice el mosaico Ezarri con los productos de instalación adecuados, obtendrá un resultado exitoso y duradero.

Un installateur professionnel, utilisant la mosaïque Ezarri avec les bons produits d'installation, obtiendra un résultat réussi et durable.

Warranty

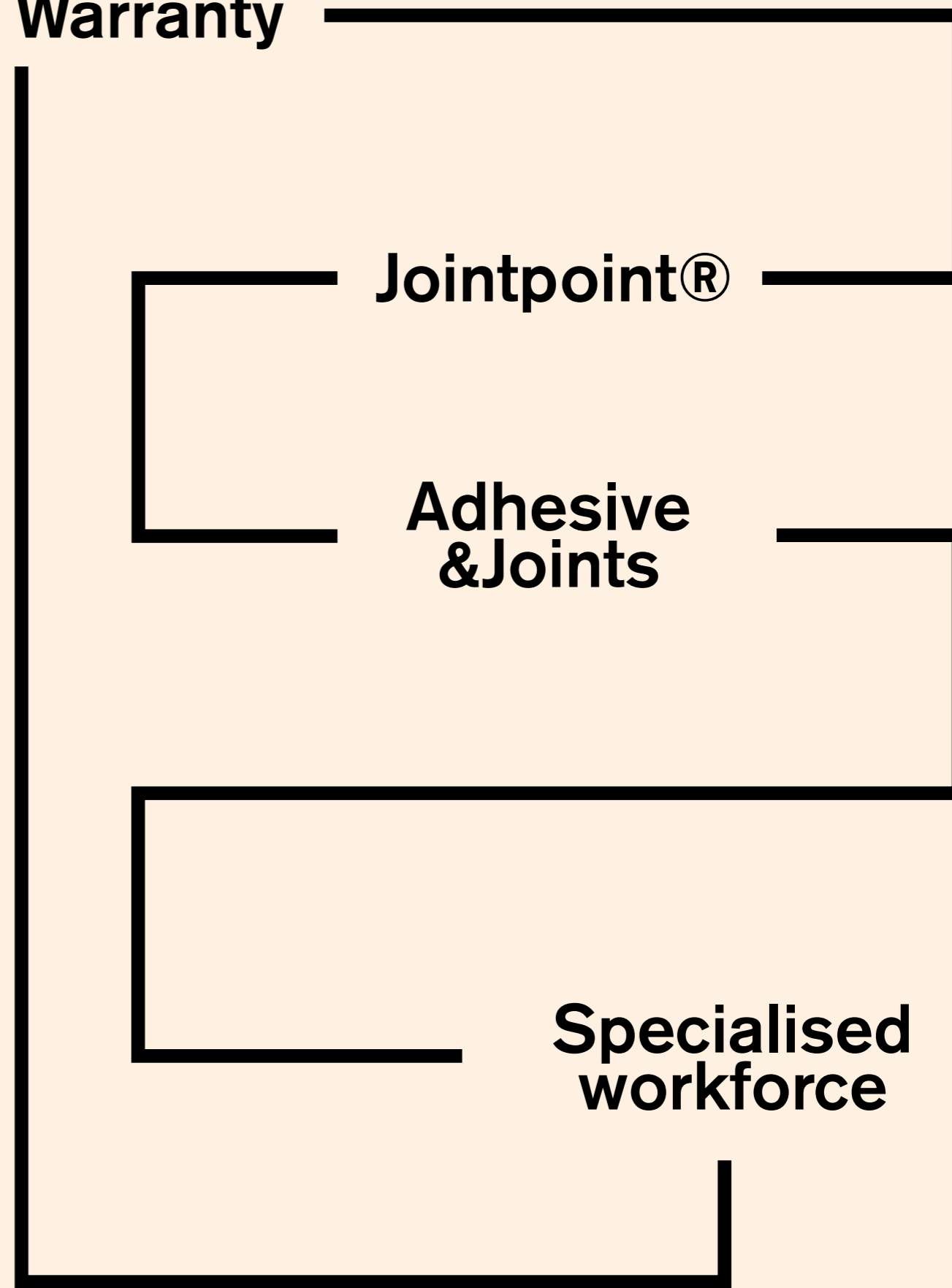

Jointpoint®

Adhesive & Joints

Specialised workforce

Support & Mosaic Academy

Technical consulting service and installation training

Servicio de asesoría técnica y academia de instalación

Service de conseil technique et académie d'installation

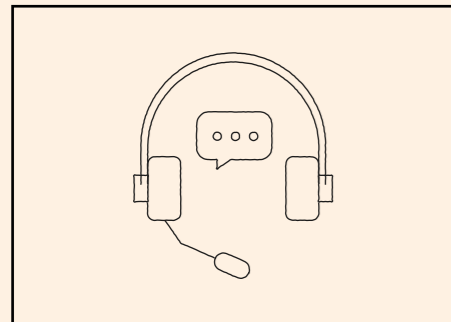
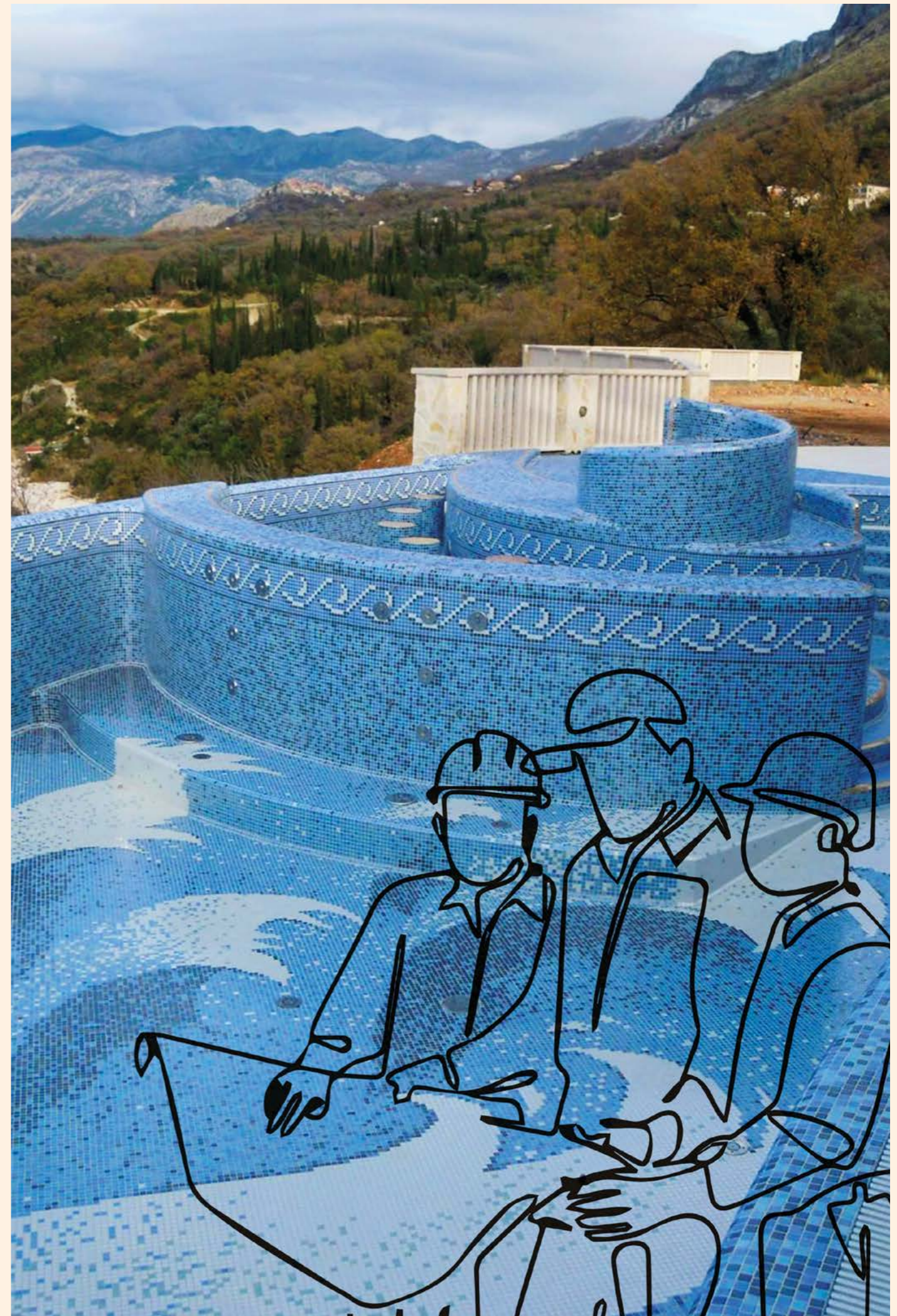

Online Support

Telephone and video-conferencing service available for your project.
 Servicio de atención telefónica y videoconferencia de proyectos.
 Service téléphonique et vidéoconférence des projets.

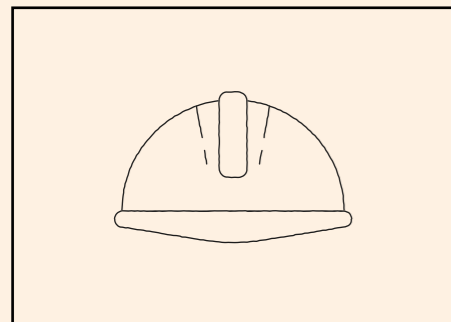

Onsite Support

Technician available to assist on-site.
 Servicio de desplazamiento de técnico a obra.
 Service de déplacement du technicien sur le chantier.

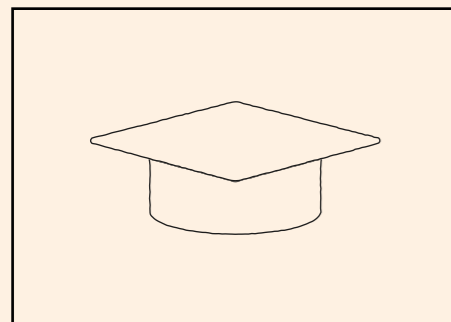

Mosaic Academy

Training available in the installation of mosaic tiles by an Ezarri professional.
 Academia de entrenamiento especializada en la instalación del mosaico por un profesional de Ezarri.
 Académie de formation spécialisée dans l'installation de la mosaïque par un professionnel d'Ezarri.

More than projects

Atlantis White Beach Club

DUBAI, UNITED ARAB EMIRATES

WAGT

RENOVATION

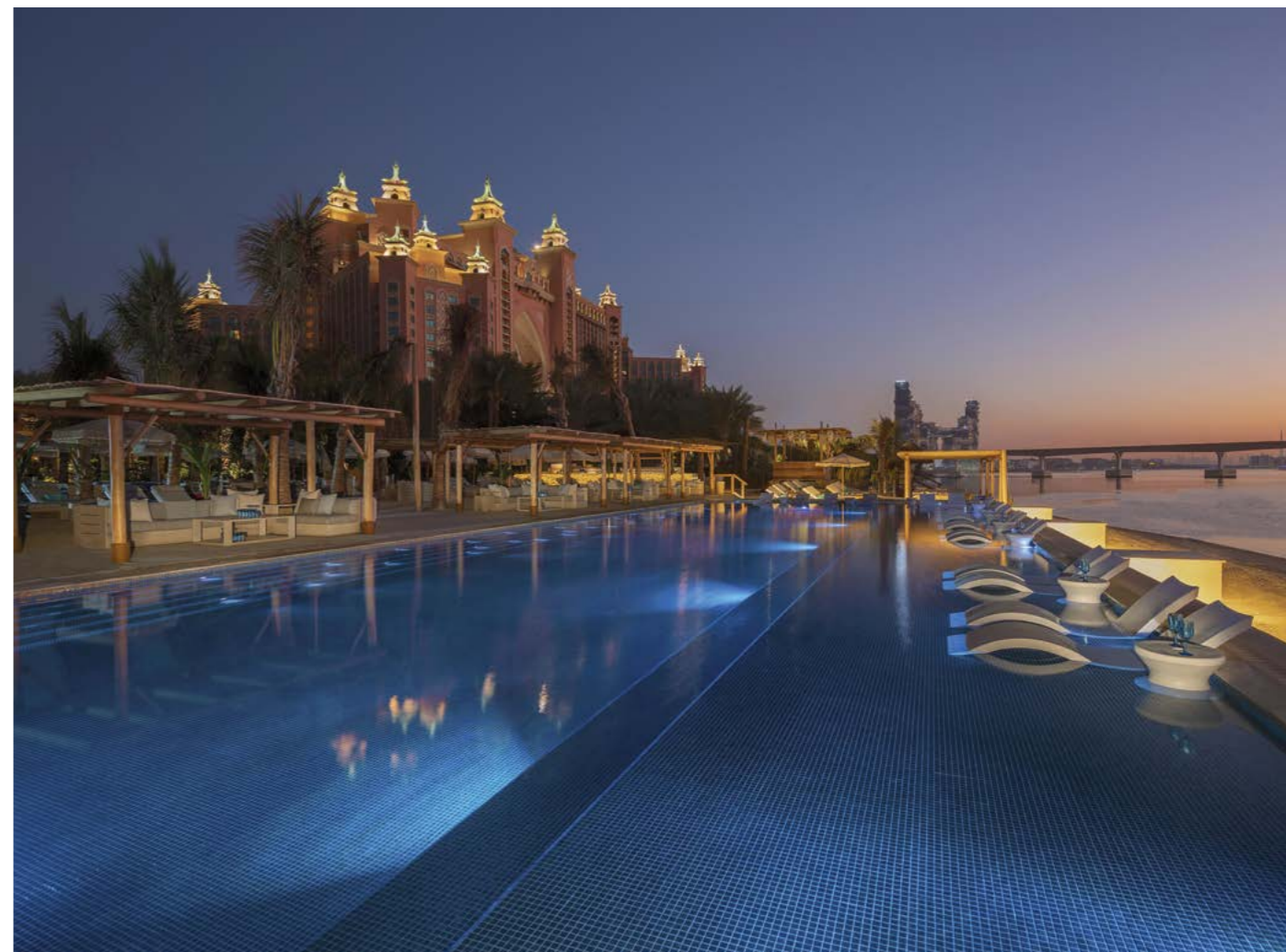

White Beach welcomes you to Atlantis Dubai's hottest beach club. Featuring an Instagram-worthy infinity pool, a chic outdoor restaurant for out-of-this-world dining and a breezy open-air terrace perfect for sunset cocktail-sipping. From this swimming pool, tiled using Jade reference from Ezarri's Iris collection, you can enjoy with views of the Dubai Skyline and the shores of the Palm Island.

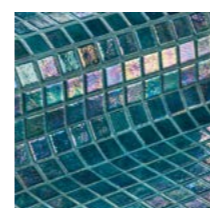

Jade

Les Roches Blanches

CASSIS, FRANCE

AGENCE KAPPEL

RENOVATION



Built in 1887 by the sea, this former mansion takes its name from the limestone rocks that line the coast from Cassis to Marseille. Located after the marina, it enjoys a unique location, between the village and the Calanques, with a breath-taking view of the majestic Cap Canaille cliff. It was not until the early 1920s that the property was transformed into a hotel and opened to the public. Winston Churchill, and later Edith Piaf, stayed there. The infinity pool (Custom Mix Mosaic of 3 dark colours) and sunbeds are perfect to look at the sunset on the mountains across the bay of Cassis

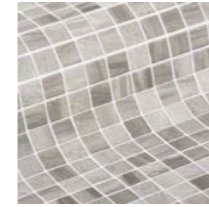

Sarsen

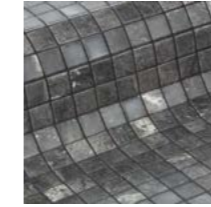

Phyllite

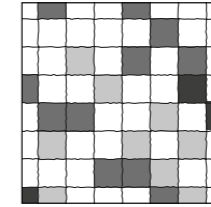

Custom Mix

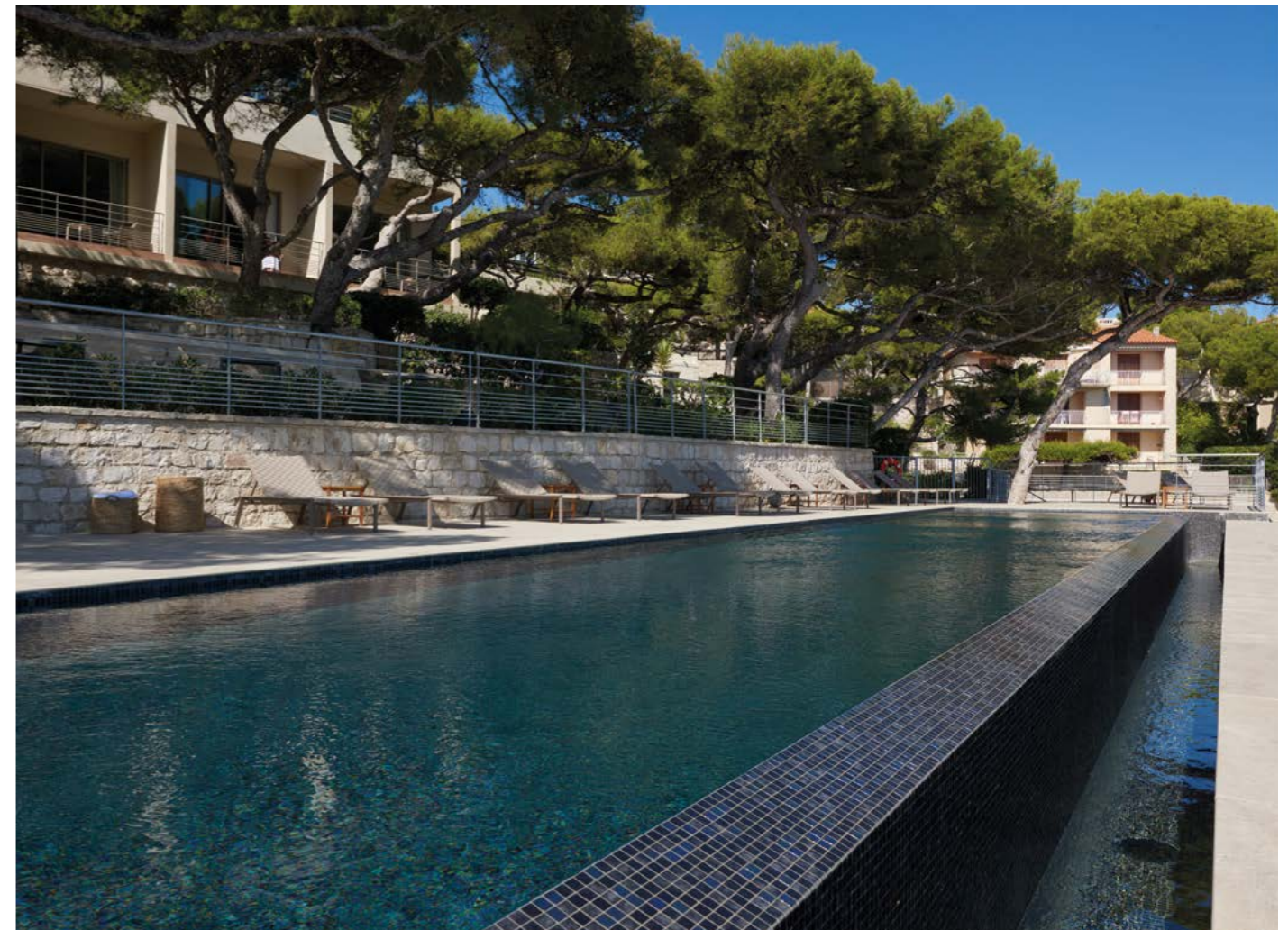

The Lodge Wine & Business Hotel

VILA NOVA DE GAIA, PORTUGAL

ARQ2525

NEW CONSTRUCTION



The Lodge Wine & Business Hotel is born from a unique spirit with an aura of timelessness that defines it as an exclusive design project. Atelier Nini Andrade Silva's interior design provides a real connection with the territory and genuine experiences and combines design with tradition. With a simply breath-taking view of the D. Luis Bridge and the Pilar Mountains, the outdoor pool, tiled with Sagittarius (Space collection) and a huge grape made with Custom Printed Mosaic, emanates an aura of contemporary urban oasis, not only because of its decoration, but also because of the drinks and light meals available at the Pool Bar.

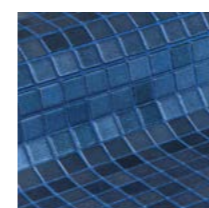
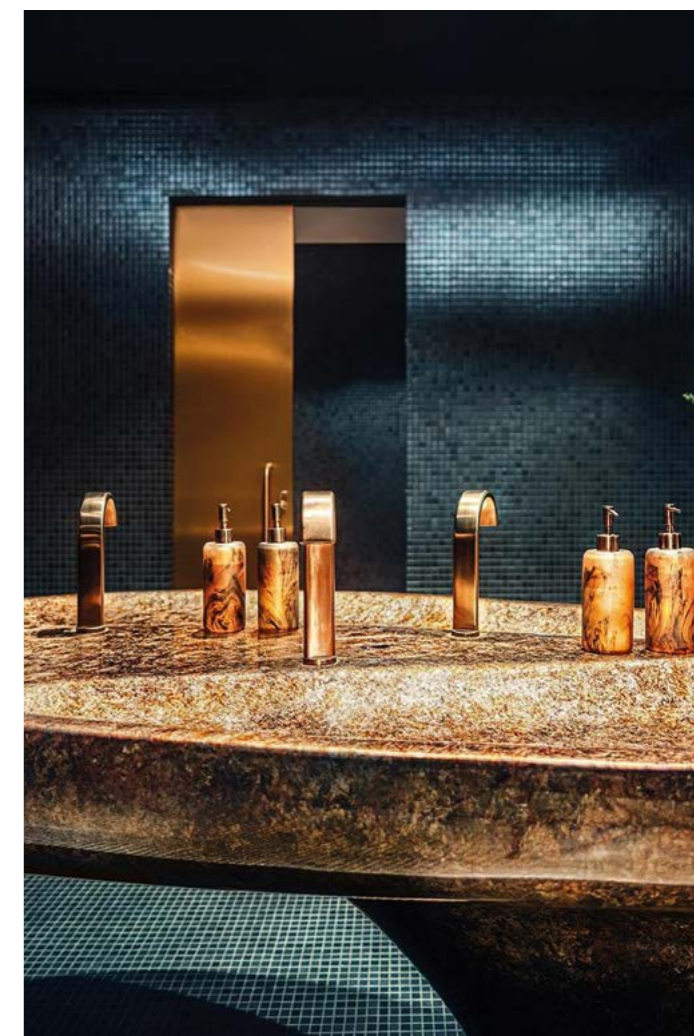

Sagittarius



Leo

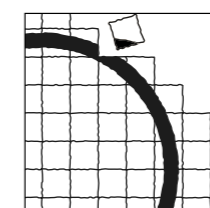

Custom Printed

Ushuaïa Ibiza Beach Hotel

IBIZA, SPAIN

ESTUDIO VILA 13

NEW CONSTRUCTION



The most exclusive and enjoyable daytime parties in an elegant hotel with a unique personality. This is what's on offer at Ushuaïa Ibiza Beach Hotel: a combination of the best music and entertainment for adults, with performances by world renowned DJs, cutting edge design, the latest technology, VIP services and a fascinating variety of gastronomy. Ushuaïa Ibiza Beach Hotel consists of two adjacent accommodations: The Ushuaïa Club, which includes an incredible swimming pool next to the stage where events are held. This is a pool tiled with Perla mosaic from Iris collection and a Custom Pixel Mosaic design in red Rubi reference, from Metal collection.

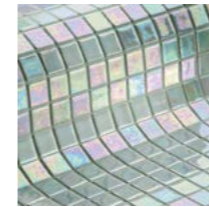

Perla



Rubi

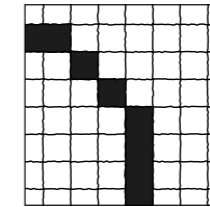

Custom Pixel

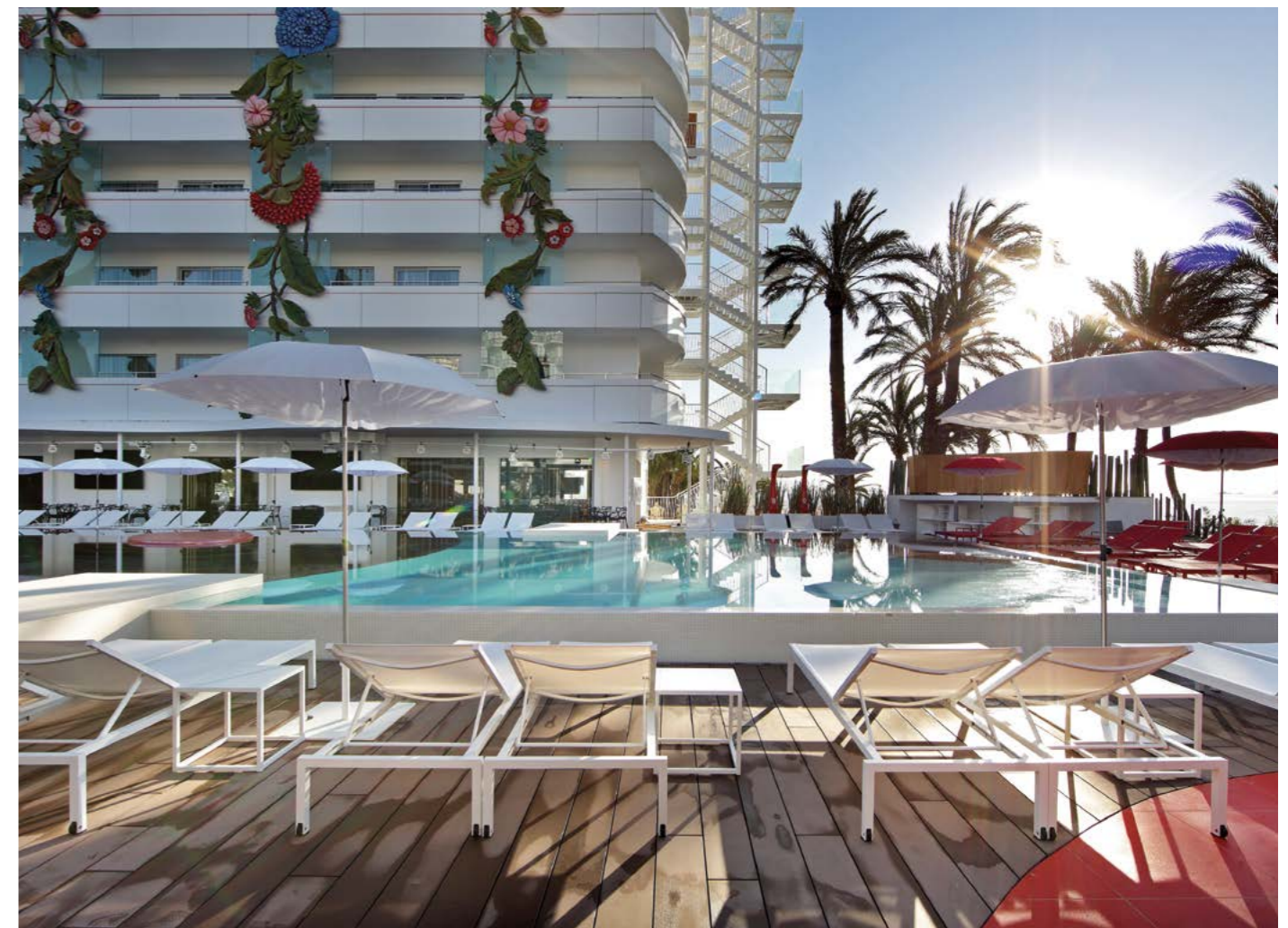

Porto Montenegro Yacht Club Pool

TIVAT, MONTENEGRO

STUDIO RHE

NEW CONSTRUCTION



The legendary Buddha-Bar restaurant group is known across the world for its Asian-inspired gastronomy and acclaimed cocktail creations. Montenegro is now the latest home for this famous luxury beach/poolside concept, with other locations in Venice, Crete and Mykonos. In this case, 80-meter-long pool with a black and white mosaic is the perfect proof.

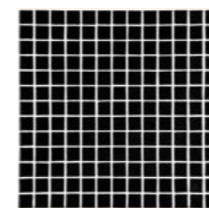
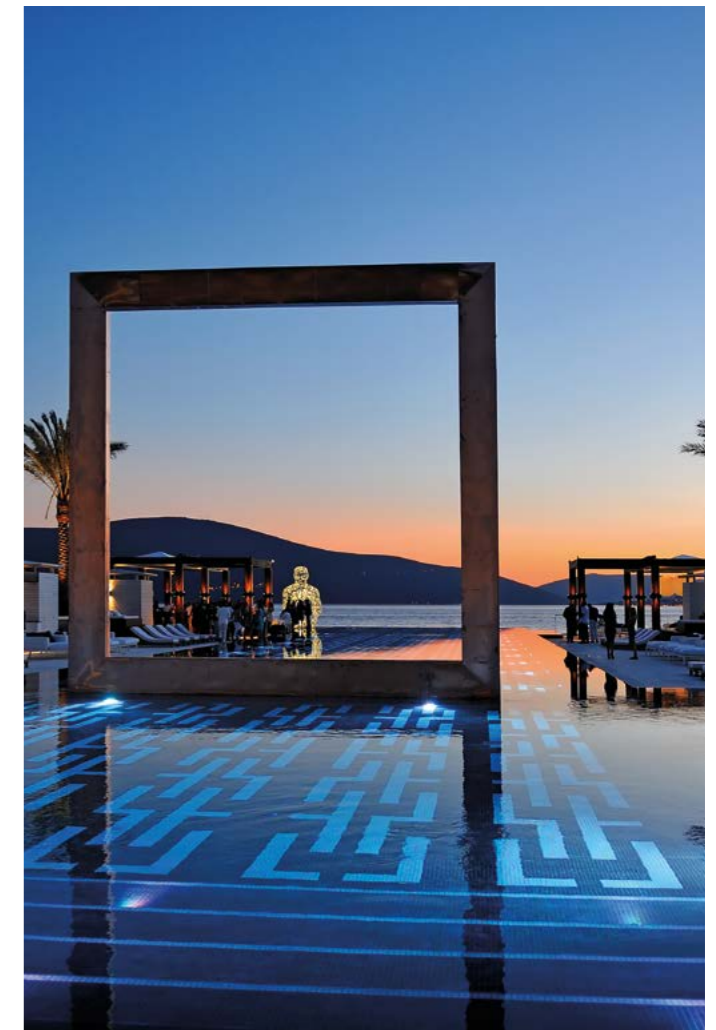

2530-D



2545-A

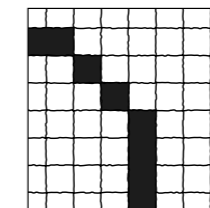

Custom Pixel

Next

FUNCHAL, PORTUGAL

RH + ARCHITECTS

RENOVATION



Relaxed ambience and modern comfort in Madeira Island, with Savoy Signature's quality seal and Ezarri mosaics in interior and exterior swimming pools. The architect selected Ambar reference (Iris collection) and Daikiri (Cocktail collection) to create a unique space.

Push the refresh button, let the Atlantic breeze welcome you. The over-the-top pool and bar haven are compatible with the networking and mingling.



Daikiri

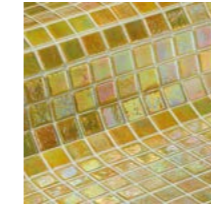

Ambar

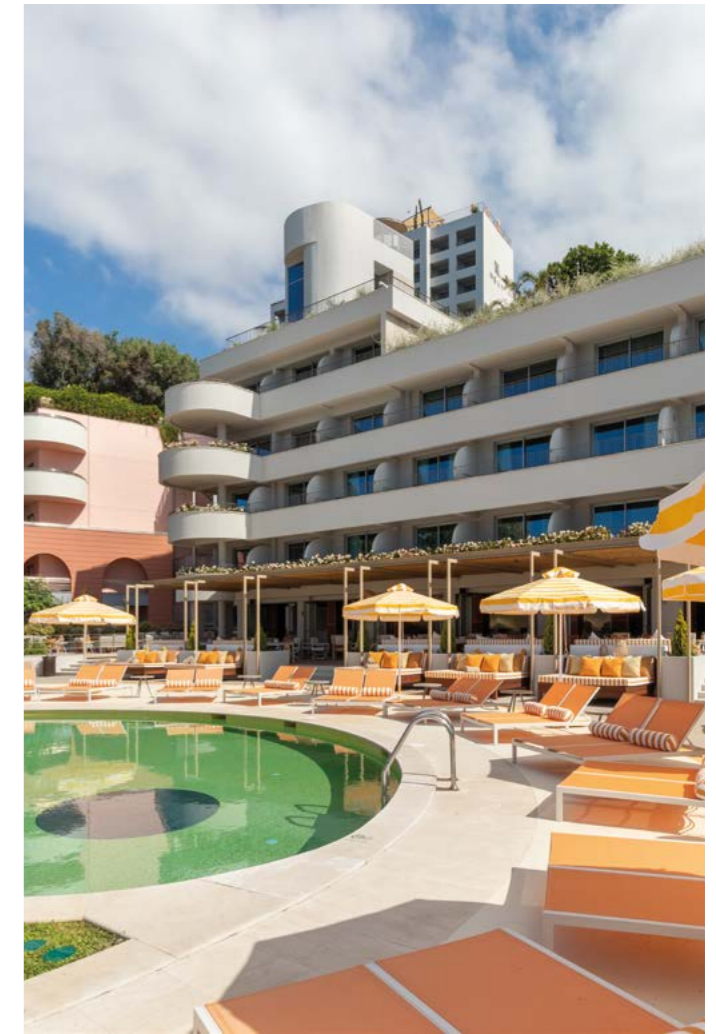

Nhow Rotterdam Hotel

Surround yourself with the latest design, art & architecture from Rotterdam, in a hotel designed by renowned architect Rem Koolhaas (OMA). Contemporary rooms with floor-to-ceiling windows to enjoy your stay and magnificent views. All bathrooms are tiled with white mosaics, 2545-A from Lisa collection.

ROTTERDAM, NETHERLANDS

REM KOOLHAAS

NEW CONSTRUCTION



2545-A



Bisha Hotel Toronto

TORONTO, CANADA

WALLMAN ARCHITECTS

NEW CONSTRUCTION

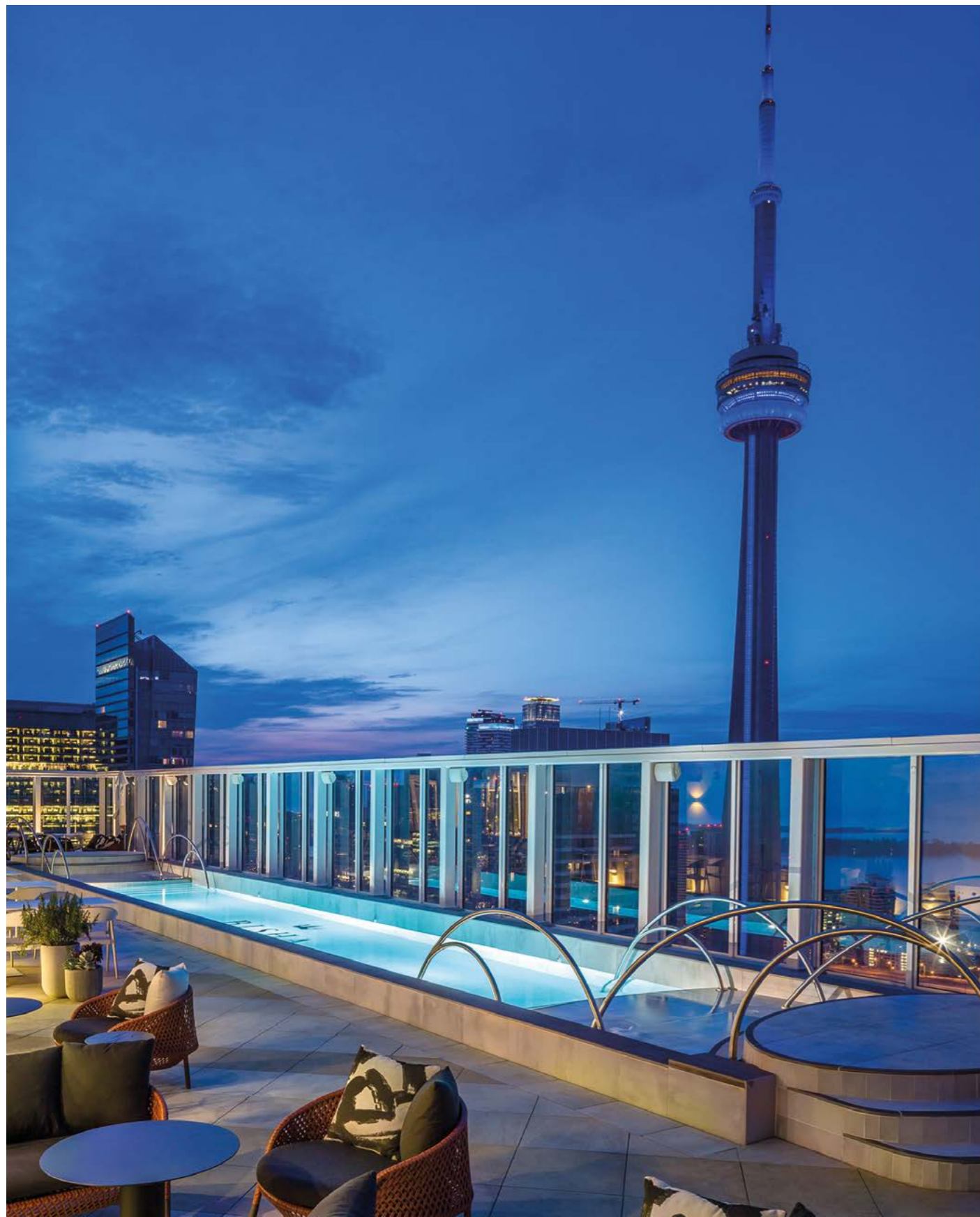

Bisha Hotel and Residences is the newest private-label boutique brand to originate in Toronto since Four Seasons Hotels and Resorts was introduced in the 1960s. Rising to 44 storeys and designed by award-winning Rudy Wallman of Wallman Architects, the Bisha flagship property will be situated in the heart of the Entertainment District on Blue Jays Way. Experience Toronto's best views from the rooftop and enjoy the infinity pool. White mosaic (2545-A from Lisa collection) was selected and hotel's logo and name produced using Ezarri's Custom Printed Mosaics.



2545-A

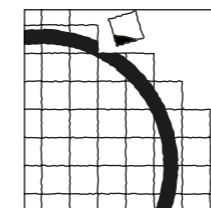

Custom Printed



Pacuare Lodge

LIMÓN, COSTA RICA

STAGNO STUDIO

NEW CONSTRUCTION

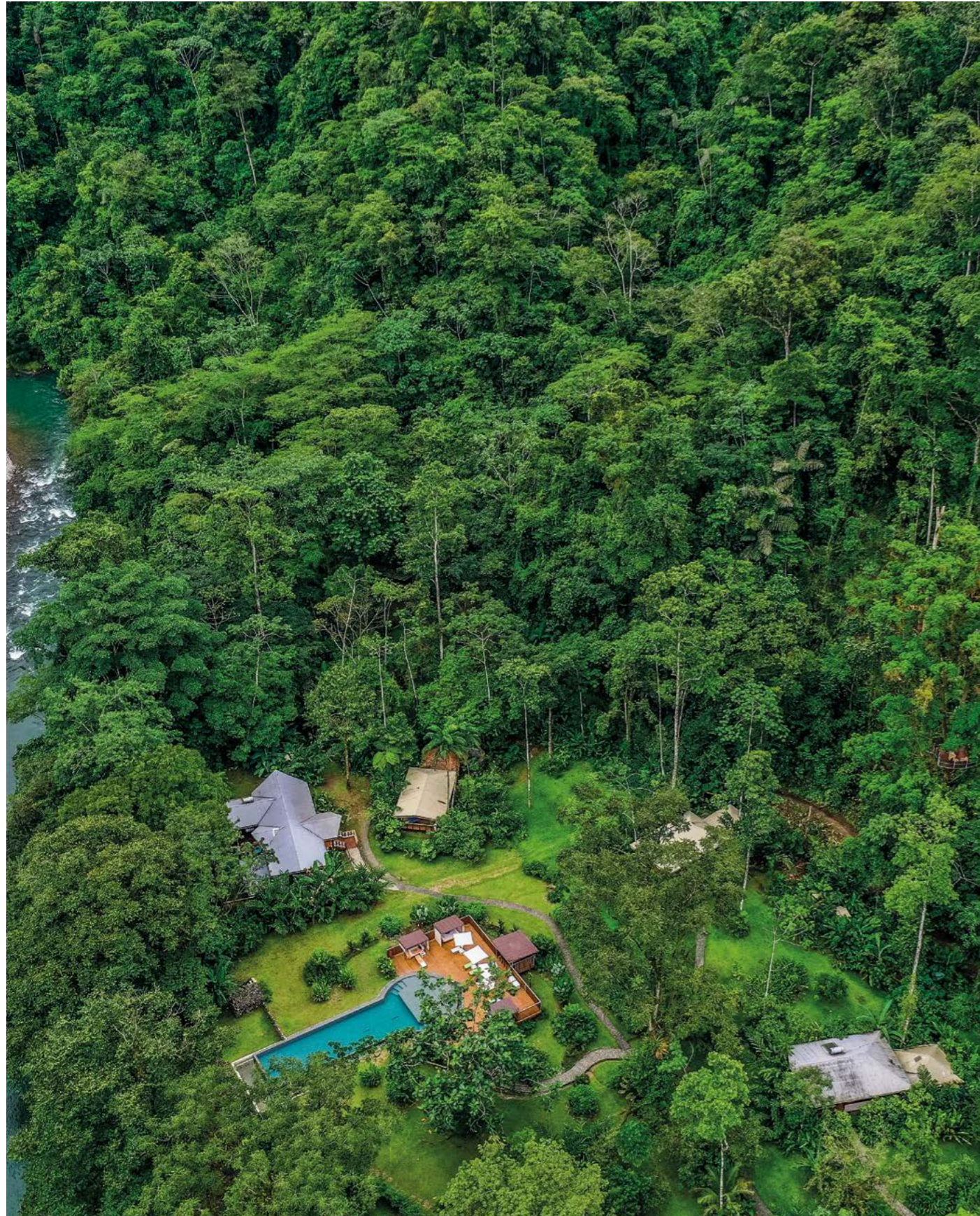

Eco-hotel situated on the banks of one of the world's most scenic, white-water wonders, the Pacuare River. The Iconic Infinity Pool, designed to have a minimum impact on the environment while capturing the ethereal beauty of its surroundings, is a 20-meter (65 feet) saltwater pool and has all the qualities of a rainforest dream come true. Hovering over the banks and spray of the river below at one end and reaching deep into the rainforest foliage at the other, the pool is an experience like no other. Architects selected Phyllite (Zen collection) so that Guest will be enticed into hours of leisurely laps in the cool waters or succumb in delight to the kiss of a jungle breeze on sun-warmed skin.

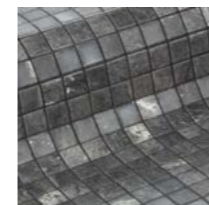

Phyllite

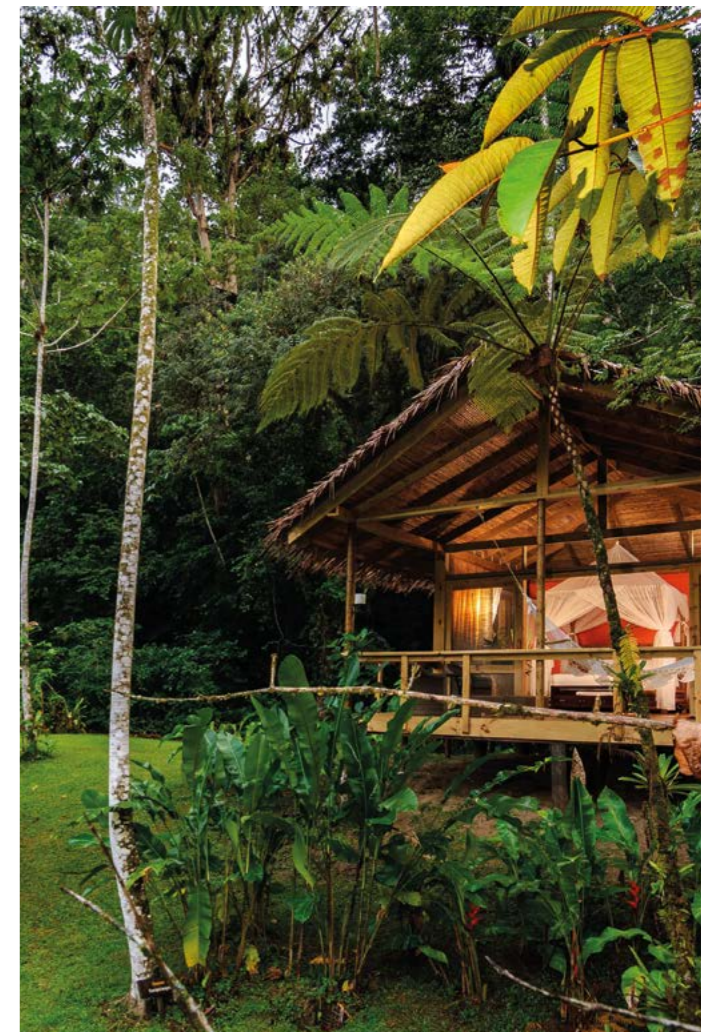

W Amman Hotel

AMMAN, JORDAN

UDESIGN ARCHITECTURE
& INTERIORS

NEW CONSTRUCTION

Begin your discovery at W Amman by entering through an intriguing canyon walk, a breath-taking recreation inspired by the ancient city of Petra, one of the Seven Wonders of the World. Light up your arrival with the Tree of Life! The tree found at the entrance is a modern interpretation of local culture and made vibrant pops of playful colour infused into Bedouin fabrics. Finally, enjoy the outdoor terrace with a heated pool (customized pixel pattern created with Lisa range tiles), with some stunning views of the Al-Abdali district and the city of Amman.

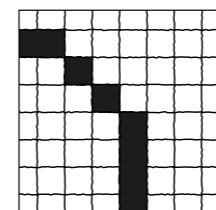
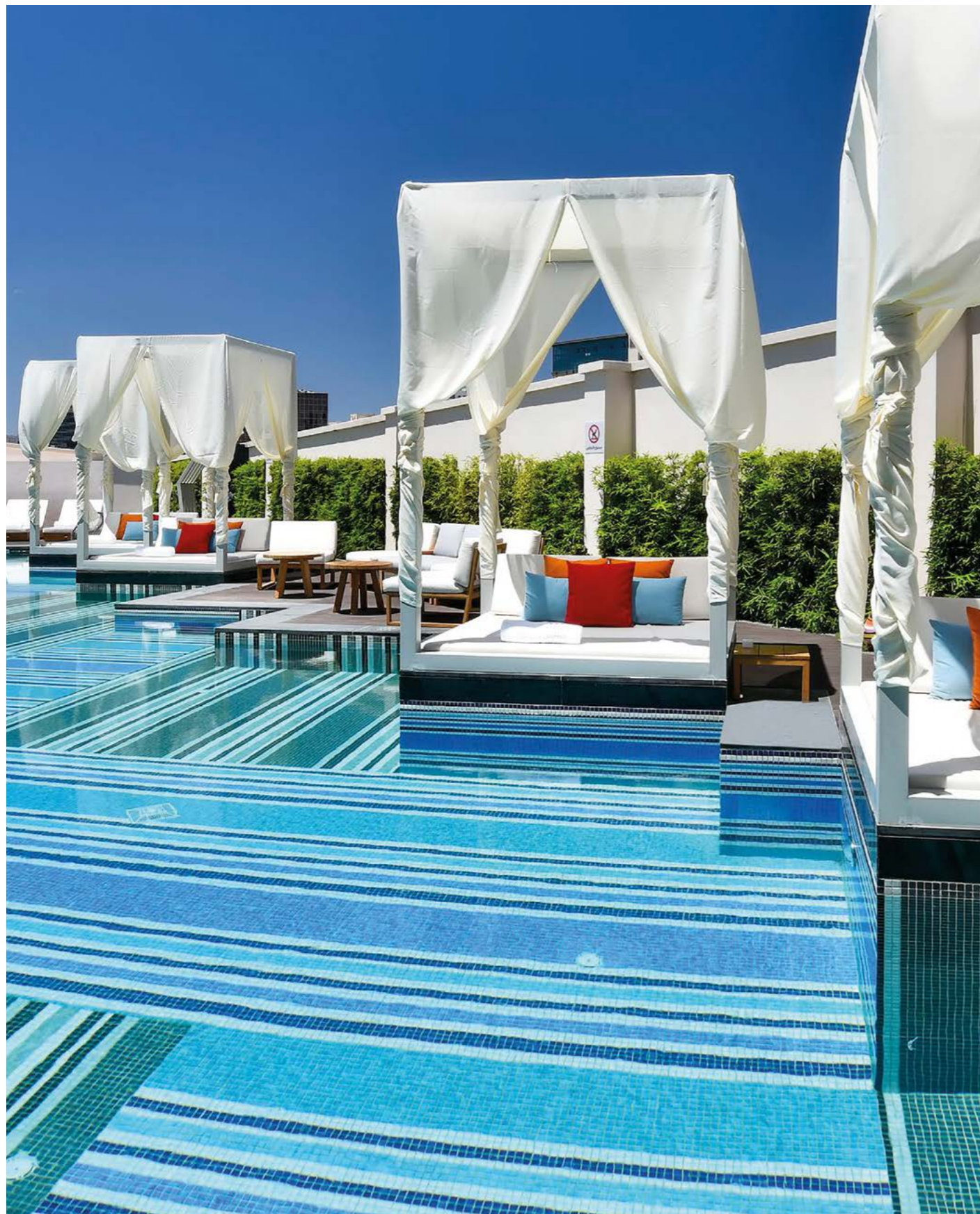

Custom Pixel



Topas Ecolodge

SAPA, VIETNAM

DUC ARCHITECT

NEW CONSTRUCTION

Sapa is a popular tourist destination in northern Vietnam and a natural starting point for those discovering the unique mountainous area, including the Hoang Lien Son mountain range and Mt Fansipan – Indochina’s highest peak. Topas Ecolodge is designed as a simple retreat set within pristine natural surroundings and therefore facilities have been kept to a minimum. Most folks love to spend time in the two saltwater infinity pools (Green Pearl reference from Iris collection) offering impressive views of the area.

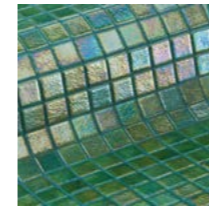

Green Pearl

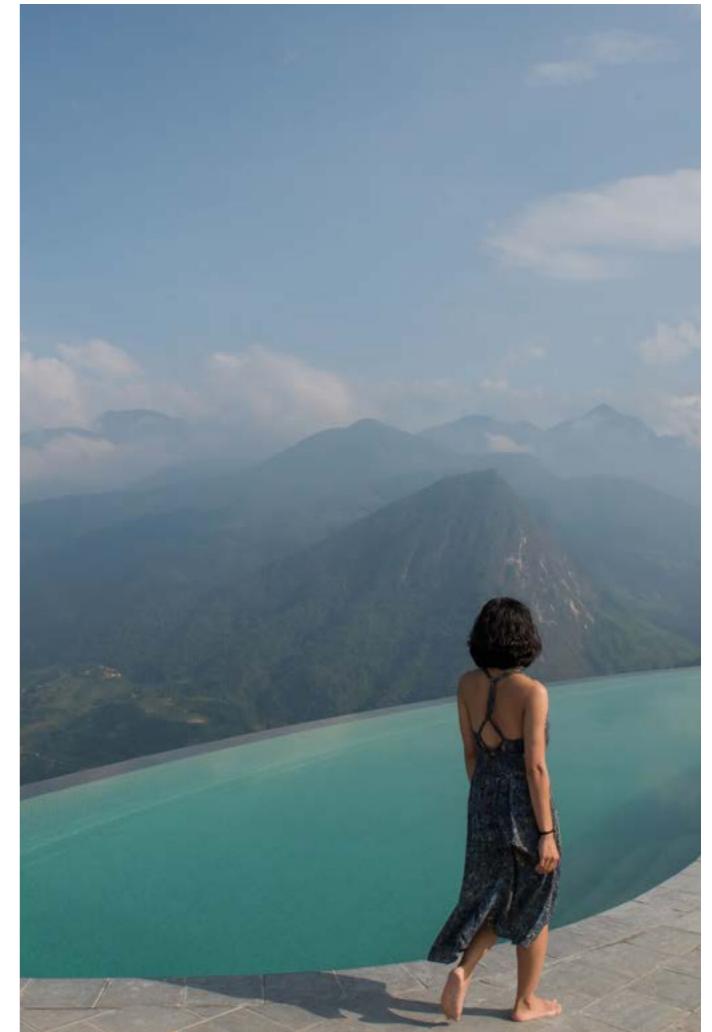

Park Hyatt Sydney

SYDNEY, AUSTRALIA

BAR STUDIO

RENOVATION

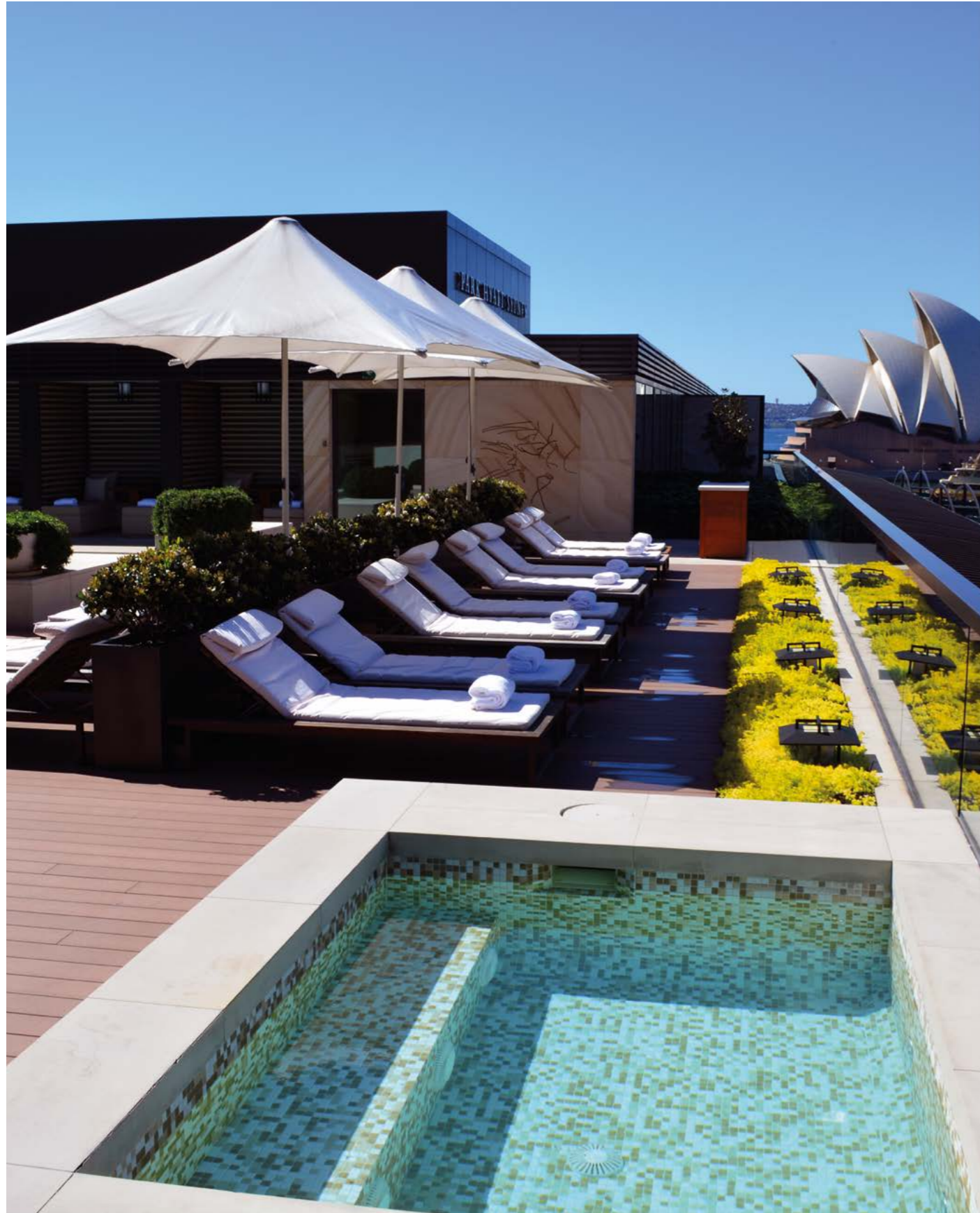

At Park Hyatt Sydney, wake up to unrivalled views of the Sydney Opera House. Explore the vibrant Rocks village, filled with cobbled laneways, cafés, art galleries, museums, and luxury stores. Enjoy the rooftop swimming pool with sweeping views of Sydney Harbour. The architect selected an antislip Custom Mix made of 2545-A Safe, Arena Safe and 2513-A for this space.

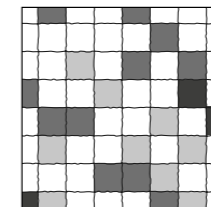
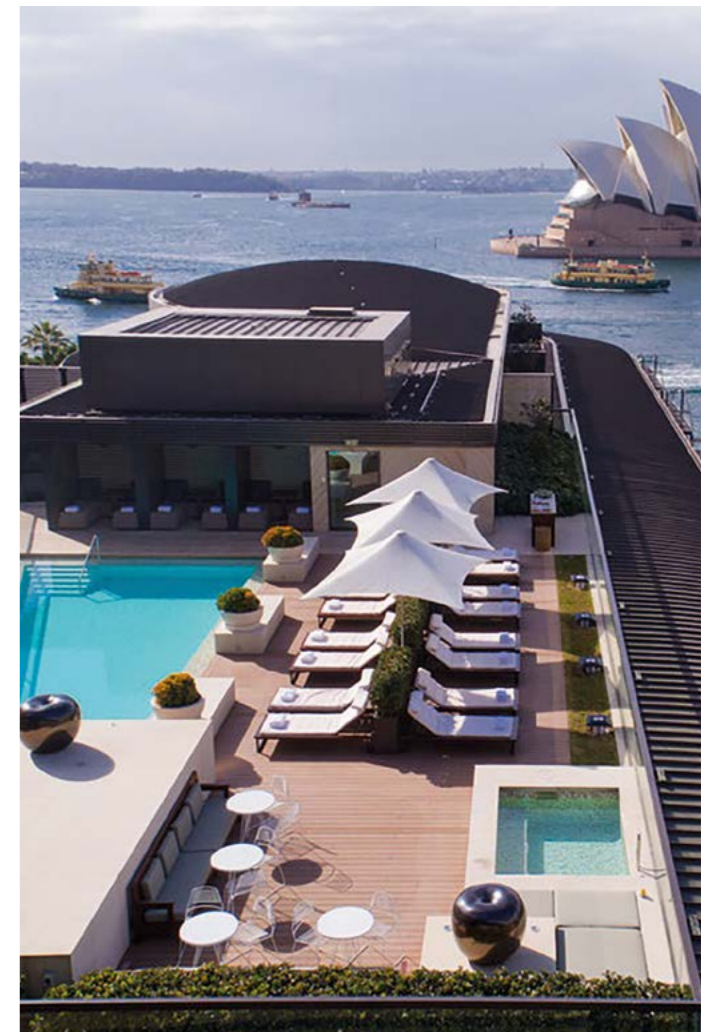

Custom Mix



Arena Safe



2545-A Safe

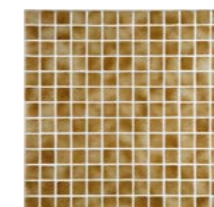

2513-A

Hard Rock Hotel Tenerife

TENERIFE, SPAIN

ESTUDIO VILA 13

NEW CONSTRUCTION



This is a stylish and contemporary music-inspired hotel located on the paradise island of Tenerife, one of the most fascinating and diverse destinations in the world, with an average temperature of 22 degrees all year round. From its location in Playa Paraiso, facing the Atlantic Ocean, with panoramic views of the island of La Gomera and Mount Teide, on the sunny south coast of Adeje, the Hard Rock Hotel welcomes you with unique experiences for all ages and excellent services. There are 2 big exterior Swimming pools and sunbeds, all tiled with Custom Mix Mosaics for an unmistakable atmosphere.

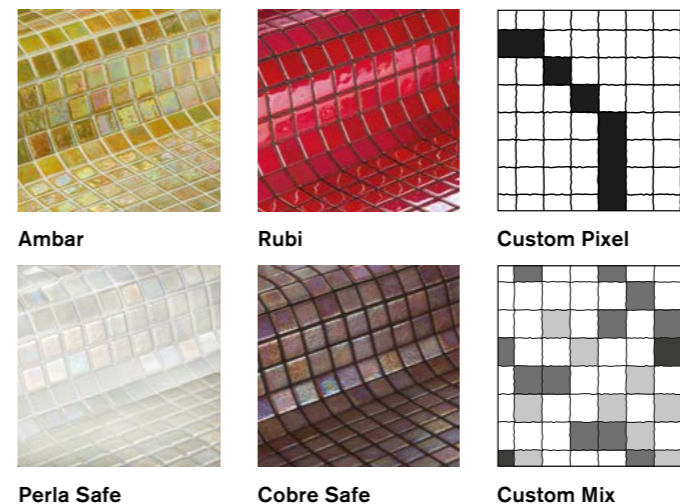

Pestana CR7 Funchal

FUNCHAL, PORTUGAL

CRISTINA MATOR

NEW CONSTRUCTION



Born from a collaboration between Cristiano Ronaldo and the Pestana Hotel Group, this lifestyle hotel offers contemporary design, making it Funchal's latest hotspot.

Original rooftop infinity pool, tiled with red mosaic colour (2506-C reference) in honour of Portugal's national team, along with the sauna and outdoor Jacuzzi.

Take in one of the best sunsets on the island from there!

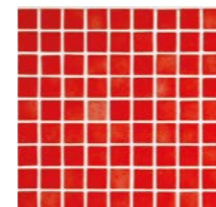

2506-C

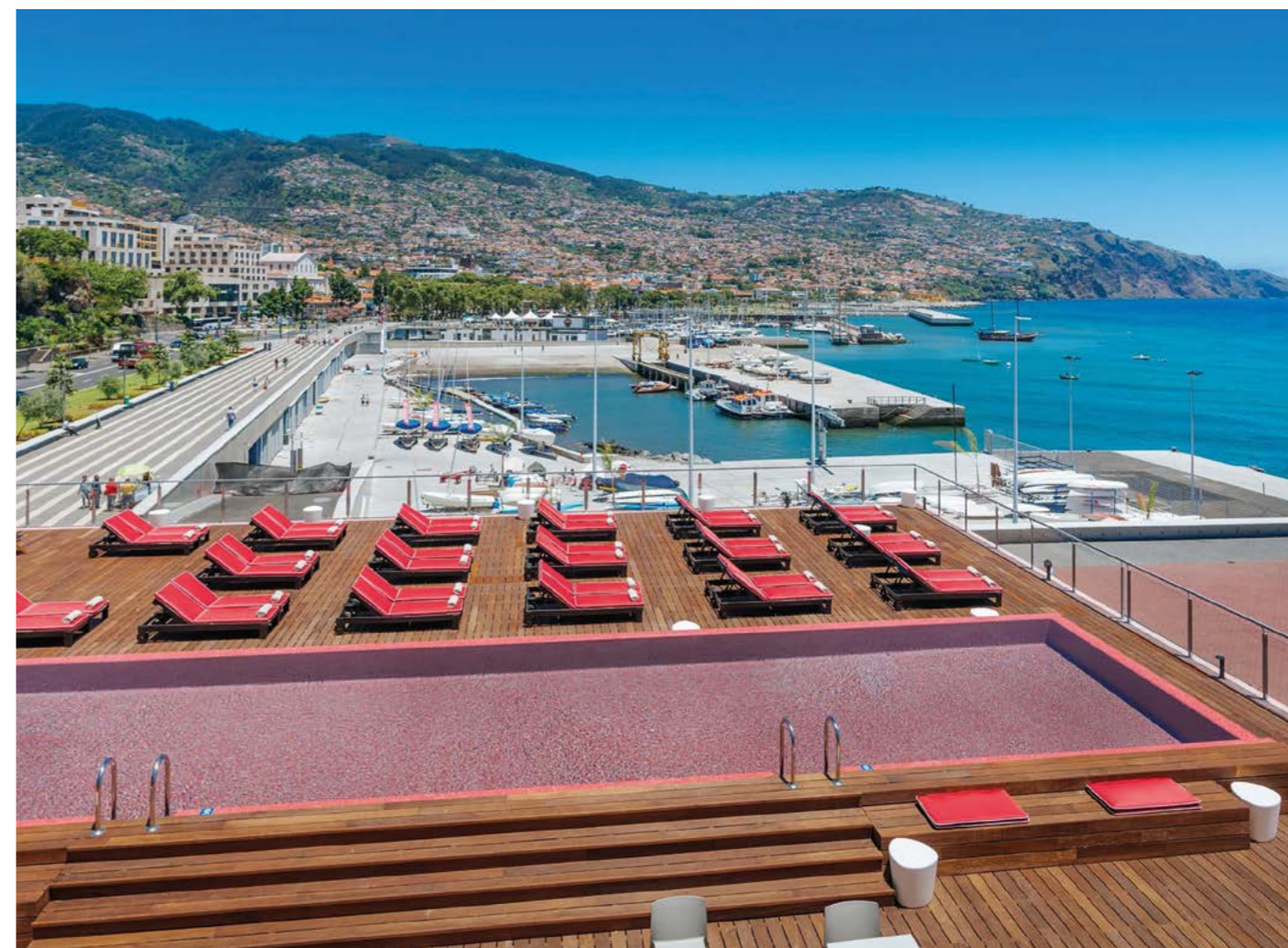
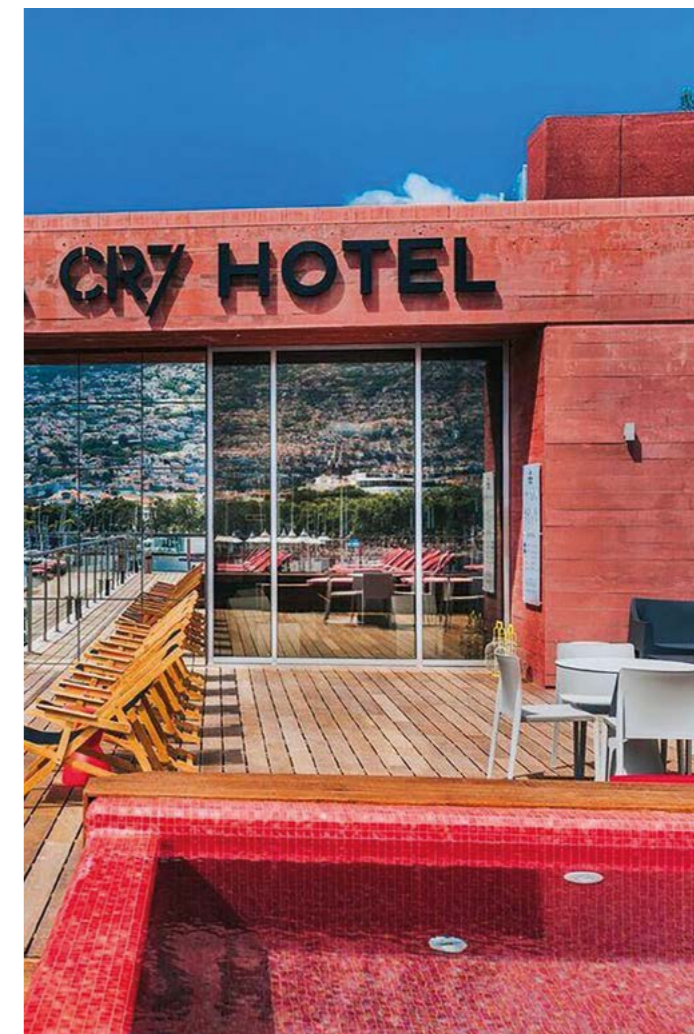

Iberostar Selection Paseo de Gracia

BARCELONA, SPAIN

IBEROSTAR CONSTRUCTION
AND PROJECT DEPARTMENT

RENOVATION

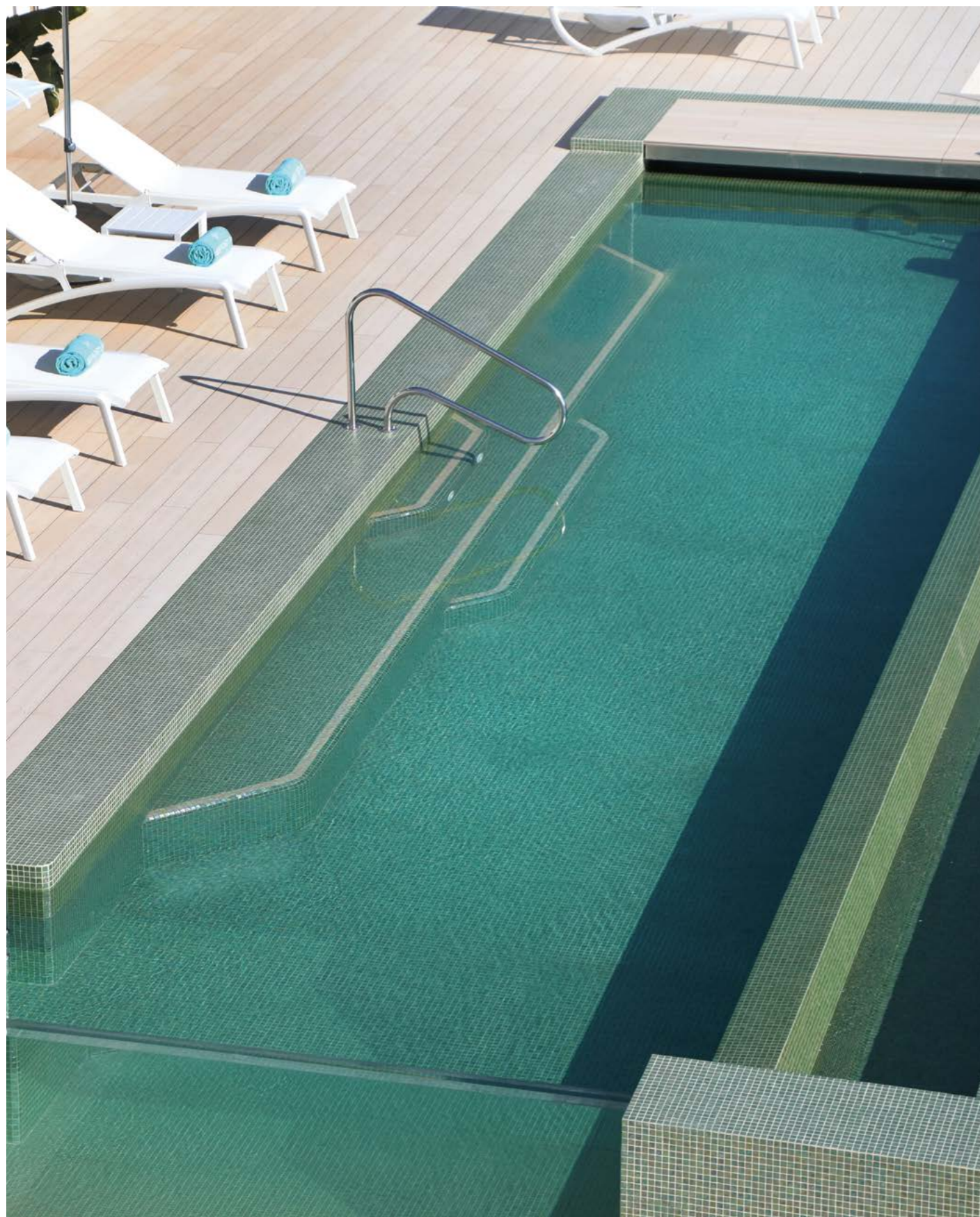

This is a hotel that inspires modernity and design. It is in the heart of Barcelona and on the city's most iconic avenue, close to the theatres located on La Rambla and Gaudi's marvellous architectural creations. Its neoclassical style blends with unique décor and artistic details throughout the hotel, such as the large mural in the courtyard, created by urban artists Boa Mistura. From the pool on the rooftop (Green Pearl, Iris collection) you can take photos of the city's most spectacular skyline.

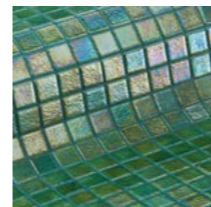

Green Pearl

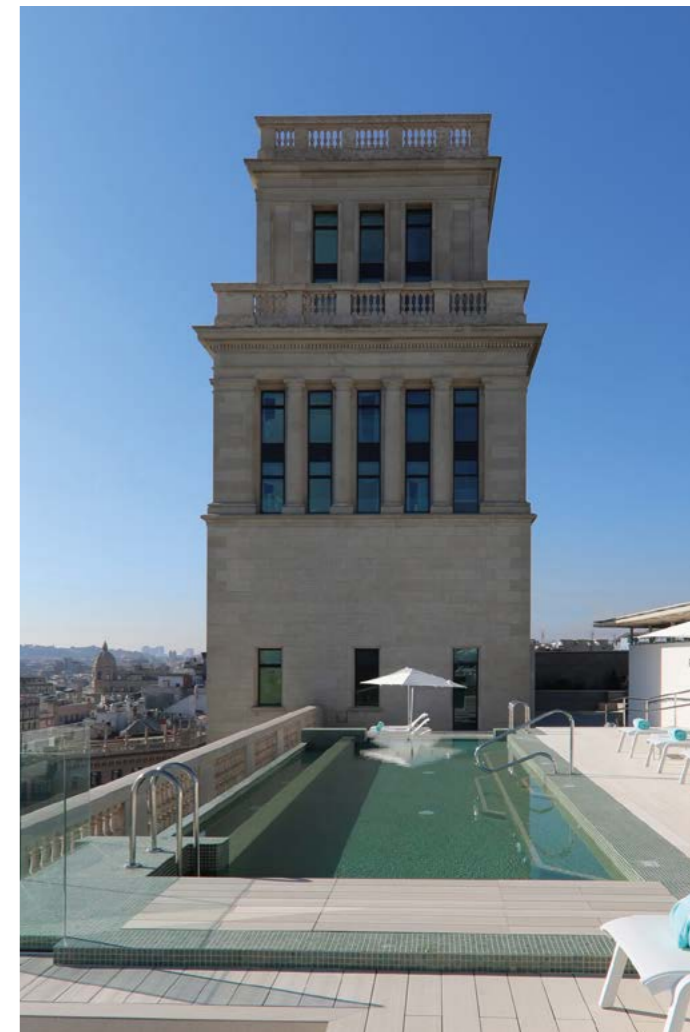

Shangri-La Barr Al Jissah Resort & Spa

MUSCAT, OMAN

WAGT

NEW CONSTRUCTION

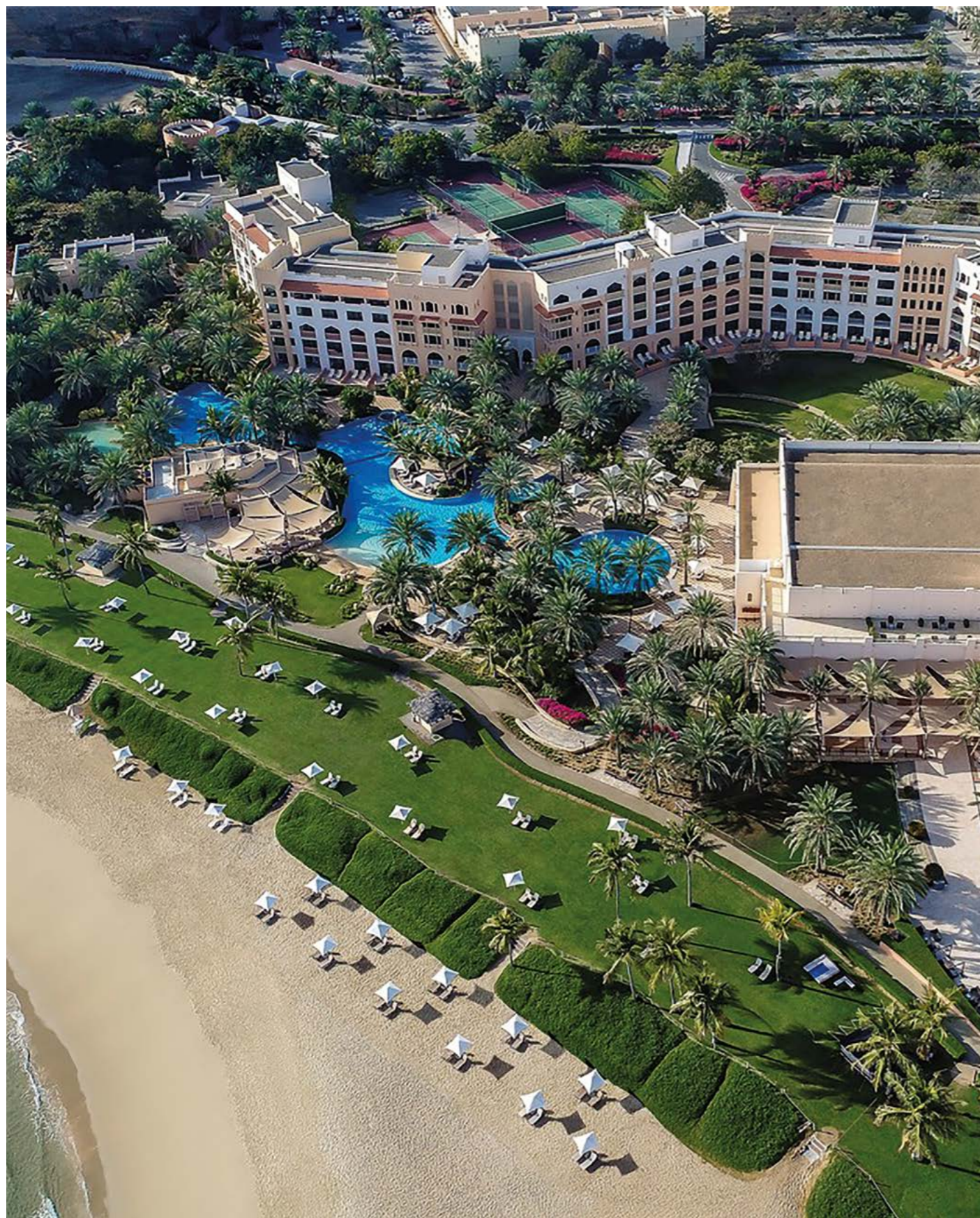

The deep turquoise blue water of the Sea of Oman is hypnotic, contrasting vividly with the majestic mountains that rise behind the resort. This is the fascination of Oman. Two hotels await your arrival. Approaching Al Waha, your excitement heightens as a man-made tunnel through the mountain leads you to a sanctuary facing the Gulf of Oman. As a family-focused hotel, Al Waha lives up to its name, with several swimming pools merging to form a serene oasis: 2508-A reference from Niebla collection was selected to achieve the same turquoise blue sea water of the Omani coast.

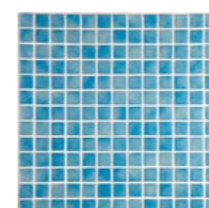
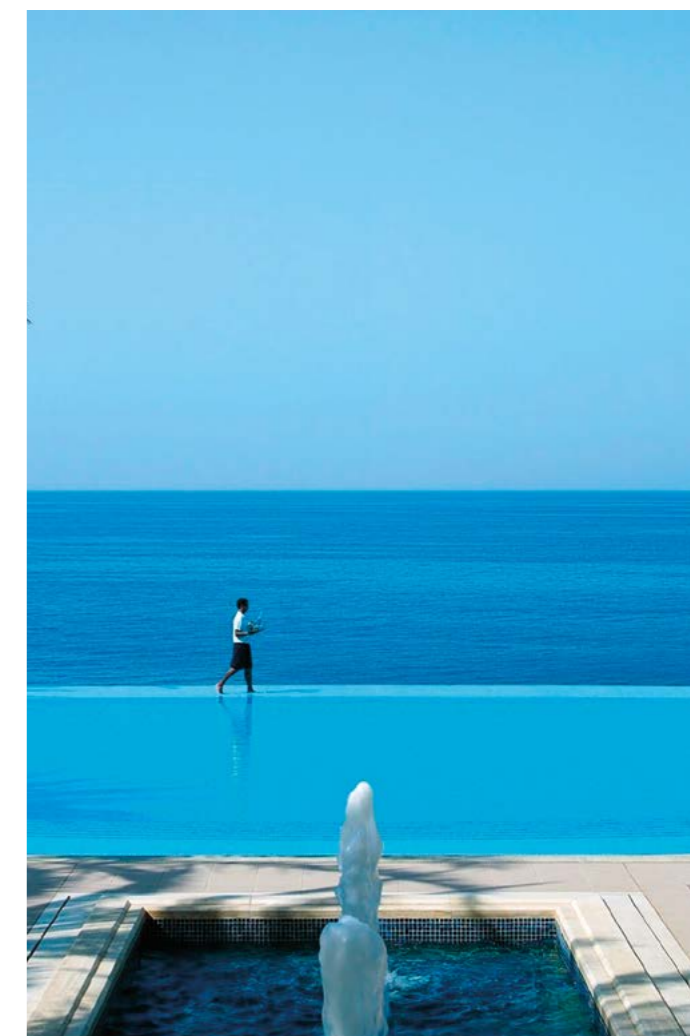

2508-A

Grand Palladium White Island Resort & Spa

IBIZA, SPAIN

RENOVATION



Located in the heart of Playa d'en Bossa, steps away from the longest stretch of beach in Ibiza, this hotel is the perfect place for families, couples and groups of friends looking to enjoy everything Ibiza has to offer. During the day, those staying at the hotel can lounge by the freshwater pool (made out of some Custom Mix Mosaics) and integrated jacuzzi, as well as many sunbeds and variety of other entertaining installations.

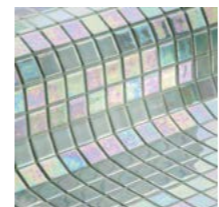

Perla



2545-A

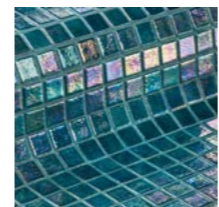

Jade

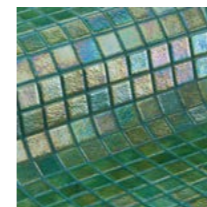

Green Pearl

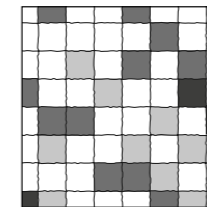

Custom Mix

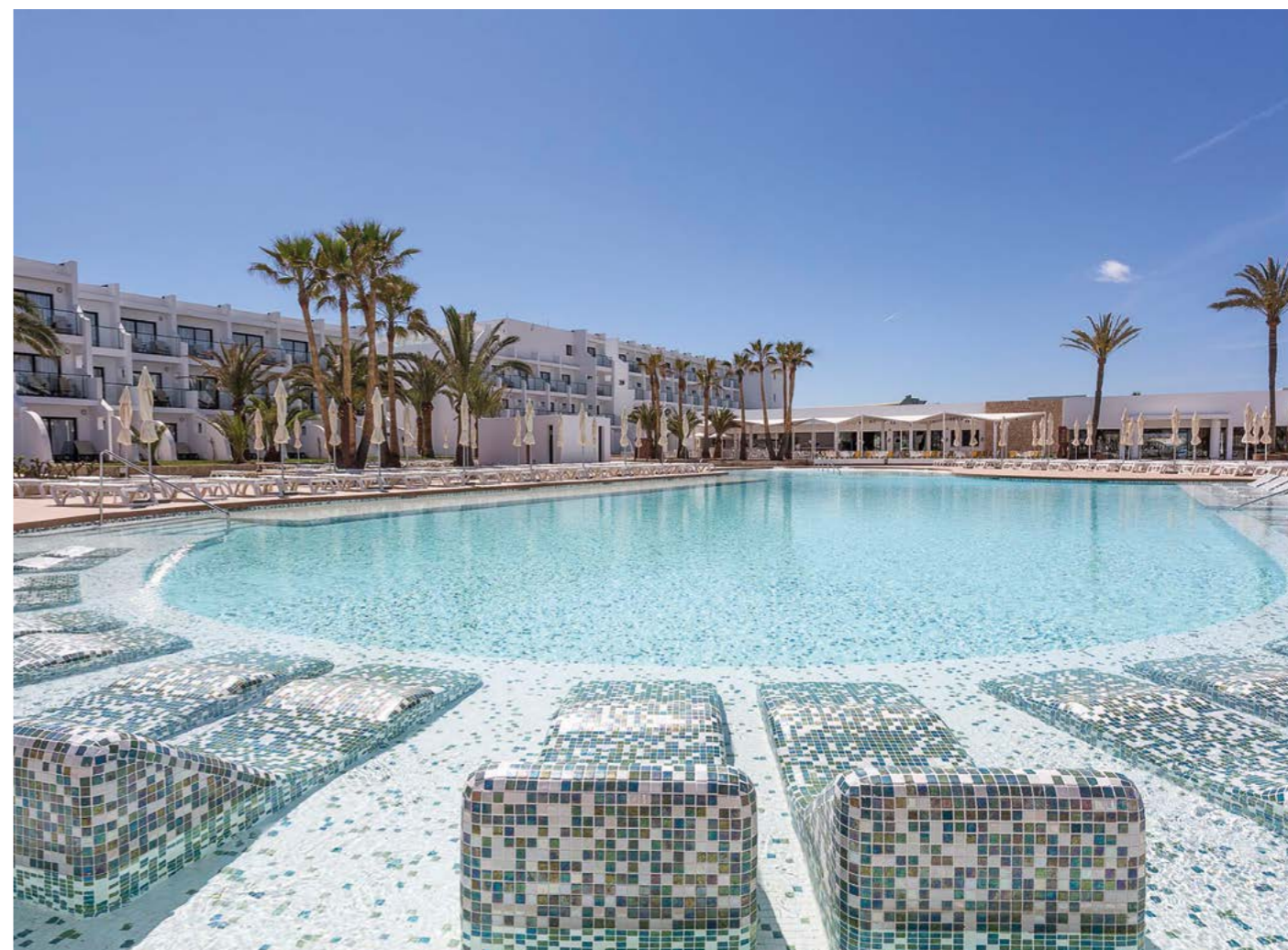

Case Studies

CANCÚN, MEXICO

Hotel Dreams Natura Riviera Cancún

Some jobs really put us to the test, and the Hotel Dreams Natura Resort and Spa is one of them. Nestled in the Mayan jungle on the Yucatán Peninsula in Mexico, this hotel looks out onto the waters of the Caribbean Sea.

Dreams is a hotel leading international resort chain, and the scope of this hotel project constituted another of our big challenges.

The network of outdoor pools covers a surface area of four thousand square metres. All are right on the beach front with its practically virgin white sands, looking out onto the beautiful Caribbean Sea.

The Resort has a huge variety of pools including communal outdoor facilities for the entire complex and mid-size pools accessible only from the bedrooms.

What's more, the breathtaking and captivating atmosphere of the spa is inspired by the cenotes, or sinkholes, of Yucatan.

Hay trabajos que nos ponen a prueba y el Hotel Dreams Natura Resort and Spa es uno de ellos. Está enclavado en la Jungla Maya de la península del Yucatán, en México. Y se ha construido frente a las aguas del mar Caribe.

La cadena Dreams es una referencia a nivel mundial. Eso hace que la dimensión de este proyecto hotelero haya sido otro de los retos fundamentales.

Las instalaciones cuentan con un entramado de piscinas exteriores que suman una superficie de cuatro mil metros cuadrados. Todas ellas frente al bello mar Caribe, en primera línea de playa con una arena blanca, prácticamente virgen.

Encontramos en este Resort una gran variedad de piscinas desde las piscinas exteriores comunes para todo el complejo hasta aquellas de un tamaño medio y que solo son accesibles desde las habitaciones.

Además, consta de un ambiente sorprendente y cautivador que es el spa realizado imitando a los cenotes del Yucatán.

CASE STUDY

Certains projets nous mettent à l'épreuve ; l'Hôtel Dreams Natura Resort and Spa est l'un d'entre eux. Il est situé dans la jungle maya de la péninsule du Yucatan, au Mexique. Il a été construit face aux eaux de la mer des Caraïbes.

La chaîne Dreams est une référence à niveau mondial. Cela fait que la dimension de ce projet hôtelier ait représenté un autre défi fondamental.

Les installations comprennent un entrelacs de piscines extérieures qui couvrent une surface de quatre mille mètres carrés. Toutes face à la belle mer des Caraïbes, en première ligne de plage de sable blanc, pratiquement vierge.

Nous trouvons dans ce Resort une grande variété de piscines : des piscines extérieures communes pour tout le complexe à d'autres de taille moyenne qui ne sont accessibles que depuis les chambres.

De plus, on y trouve une ambiance surprenante et captivante recréée par le spa qui a été réalisé en s'inspirant des cenotes du Yucatan.

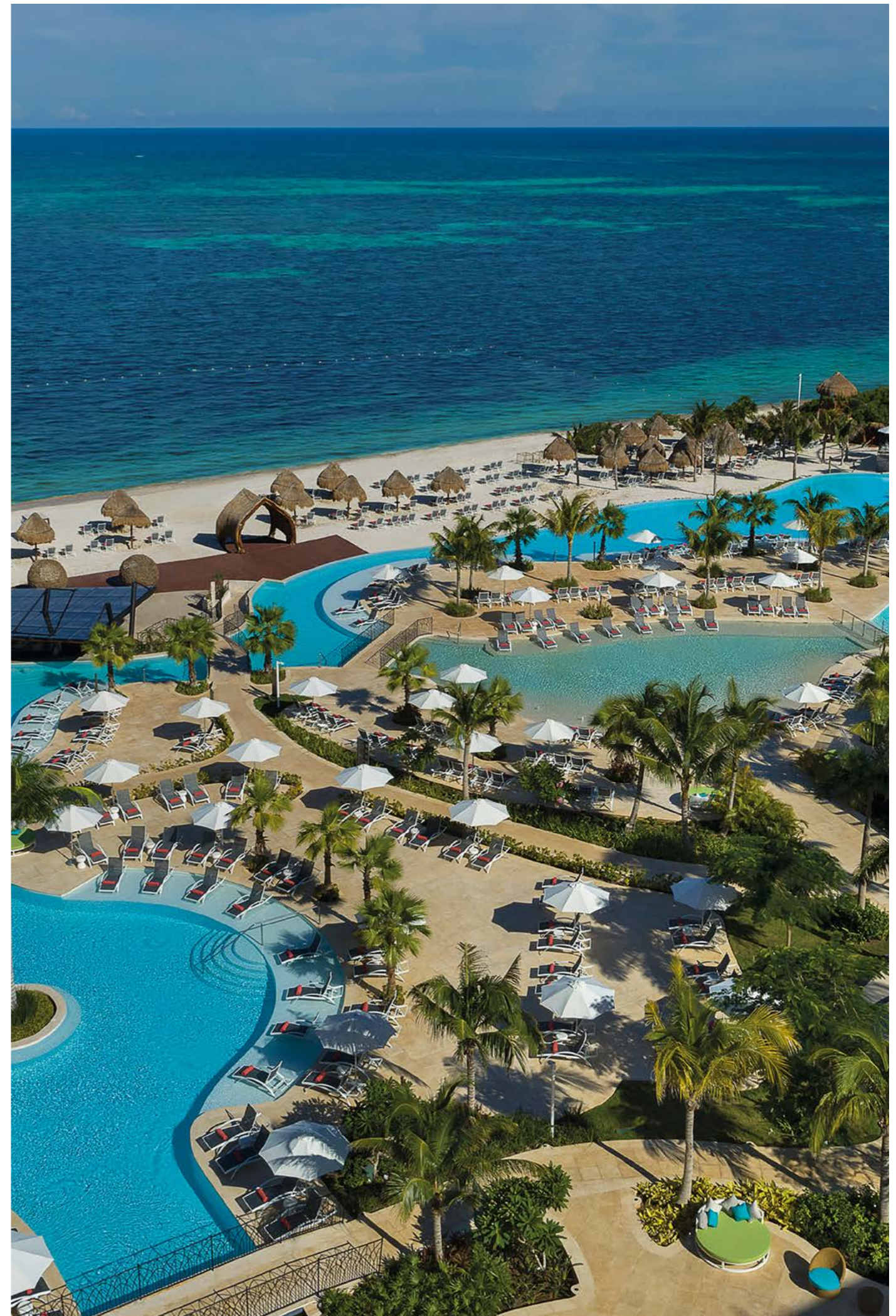



Outdoor pools

The Hotel Dreams Natura Resort and Spa has been tiled with the ref. Diamond from the Iris collection. This blend of iridescent and non-iridescent white mosaics is especially indicated for pools. It is a mosaic that encourages relaxation and pleasure. In this case, we also sought to imitate the colour of the Caribbean Sea. Blue Caribbean.



Piscinas exteriores

El Hotel Dreams Natura Resort and Spa ha sido revestido con la referencia Diamond de la colección Iris. Se trata de una mezcla de mosaicos blancos con y sin efectos iridiscentes especialmente indicado para el revestimiento de piscinas. Un mosaico que busca el relax, el placer. Y, en este caso, el objetivo era, también, imitar el color del agua del caribe. Azul caribe.

Piscines extérieures

L'Hôtel Dreams Natura Resort and Spa a été revêtu avec la référence Diamond de la collection Iris. Il s'agit d'un mélange de mosaïques blanches avec et sans effets iridescents spécialement recommandé pour le revêtement de piscines. Une mosaïque qui recherche le relax, le plaisir. Et, dans ce cas, l'objectif était aussi d'imiter la couleur de l'eau des Caraïbes. Le bleu Caraïbe.



The Wellness

One of the crowning jewels of this hotel complex is its spectacular wellness with a design inspired by the cenotes of the Yucatán Peninsula.

The passage of time has created spectacular wells of natural crystalline water in the bottom of these large natural caves.

The Hotel Dreams Natura Resort and Spa imitates the cenotes of Yucatán. To achieve this, we used the ref. Sarsen from the Zen collection for its similarity to the rocky environment in the cenotes.

The design was further enhanced using the references Gin Fizz and Alexander, both from the Cocktail collection.

El Spa del hotel

Por otro lado, una de las grandes apuestas de este complejo hotelero es su espectacular Spa, diseñado a imitación de los cenotes, cuevas típicas de la península del Yucatán.

Lo interesante de los cenotes es que son unas cuevas naturales de un tamaño considerable y en su fondo se ha creado con el paso del tiempo una espectacular poza de agua cristalina y natural.

El spa del Hotel Dreams Natura Resort and Spa imita a los cenotes yucatecos. Así, para conseguir la semejanza, se ha utilizado la referencia Sarsen de la colección Zen, que se asemeja al entorno de piedra que genera el cenote.

Además, algunos detalles del diseño se han completado con las referencias Gin Fizz y Alexander, ambas de la colección Cocktail de Ezarri.

Le Spa de l'hôtel

D'un autre côté, un des grands paris de ce complexe hôtelier est son spectaculaire spa, avec son design inspiré par les cenotes, de typiques grottes de la péninsule du Yucatan.

Ce qui est intéressant chez les cenotes est qu'il s'agit de grottes naturelles d'une taille considérable et dans leur fond s'est formée, au fil du temps, une spectaculaire réserve d'eau cristalline et naturelle.

Le spa de l'Hôtel Dreams Natura Resort and Spa imite les cenotes du Yucatan. Ainsi, pour obtenir la ressemblance, on a utilisé la référence Sarsen de la collection Zen, qui s'apparente à l'environnement de pierre que le cenote génère.

En outre, quelques détails du design ont été complétés avec les références Gin Fizz et Alexander, toutes deux de la collection Cocktail d'Ezarri.

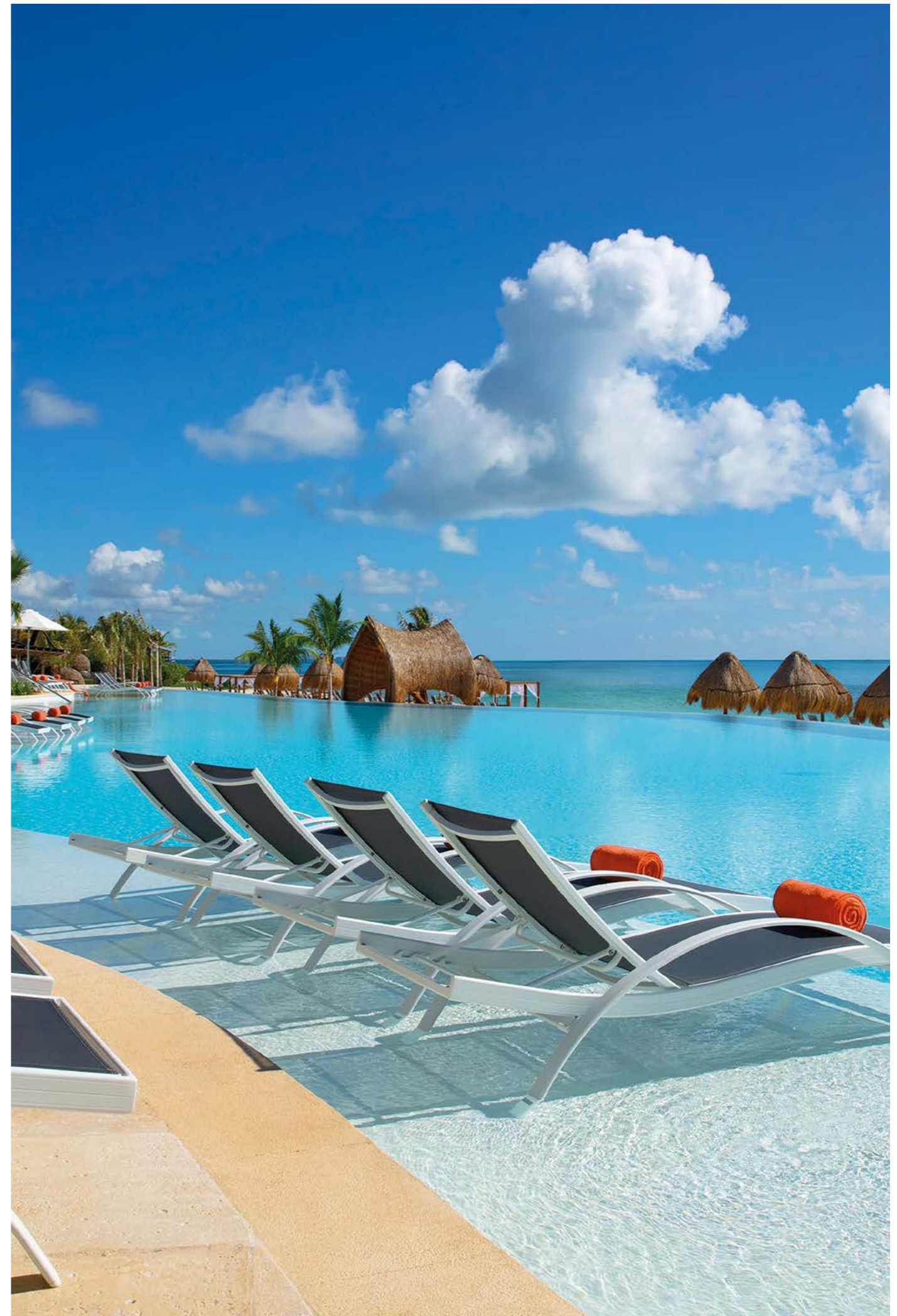

PORTUGAL

CASE STUDY

Hotel Savoy Palace Funchal

Ezarri tiled the pools at the Hotel Savoy Palace in Funchal, the capital of the Madeira Islands, in the middle of the Atlantic Ocean. With its sixteen floors, the hotel welcomes its guests with comfort, luxury and relaxation, featuring a wellness area to die for, a wide variety of restaurants, and luxurious swimming pools. And Ezarri was the company chosen to clad the pools with colour and beauty.

The Savoy Palace is a five-star hotel with five hundred rooms and spectacular ocean views. Guests can also enjoy a series of gardens that combine innovation and contemporary design - part of Ezarri's DNA - and key to being chosen for this project.

Ezarri ha revestido las piscinas del Hotel Savoy Palace en Funchal, la capital de las Islas Madeira, enclavadas en mitad del océano Atlántico. Este establecimiento hotelero es un complejo de confort, lujo y bienestar, que con dieciséis pisos, tiene mucho que ofrecer a sus clientes: desde un espacio wellness de ensueño, una amplia variedad de restaurantes, además de diversas piscinas lujosas en las que Ezarri ha sido la empresa elegida para dar color y belleza.

El hotel es un alojamiento que suma cinco estrellas, alberga quinientas habitaciones y cuenta con espectaculares vistas al océano. En este establecimiento se puede disfrutar también de una sucesión de jardines en los que se combina innovación y modernidad, aspectos por los que apuesta Ezarri y que han sido claves para ser la empresa elegida en este proyecto.

Ezarri a recouvert les piscines de l'Hotel Savoy Palace à Funchal, la capitale des îles de Madère, situées au milieu de l'océan Atlantique. Cet établissement hôtelier est un complexe de confort, de luxe et de bien-être qui, avec ses seize étages, a beaucoup à offrir à ses clients : d'un espace bien-être onirique, à une grande variété de restaurants, ainsi que diverses piscines luxueuses pour lesquelles Ezarri a été l'entreprise choisie afin de leur donner couleur et beauté.

L'hôtel est un établissement cinq étoiles, qui dispose de cinq cents chambres et offre des vues spectaculaires sur l'océan. Dans cet établissement, vous pourrez également profiter d'une succession de jardins qui allient innovation et modernité, des aspects sur lesquels Ezarri mise et qui ont été la clé pour être l'entreprise choisie dans ce projet.

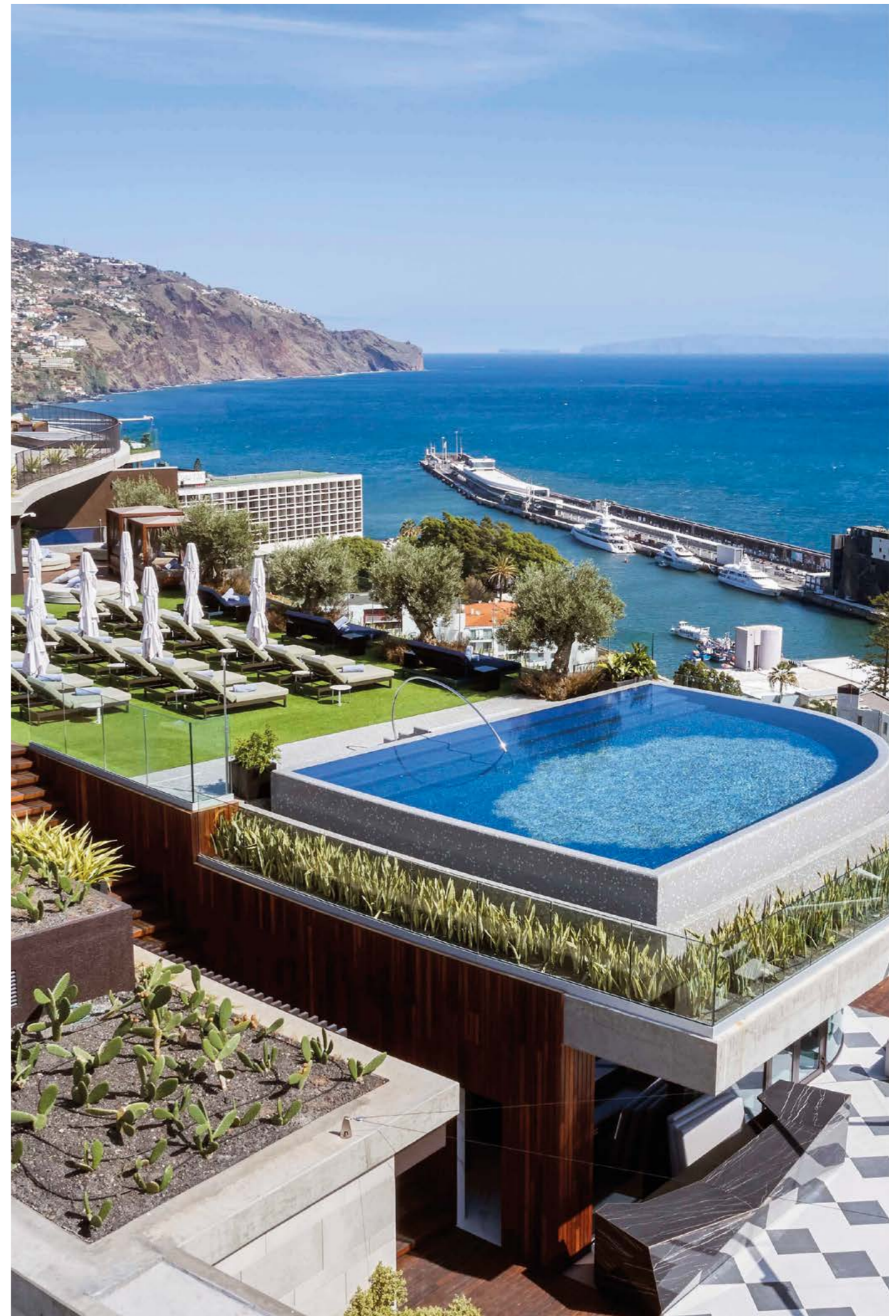

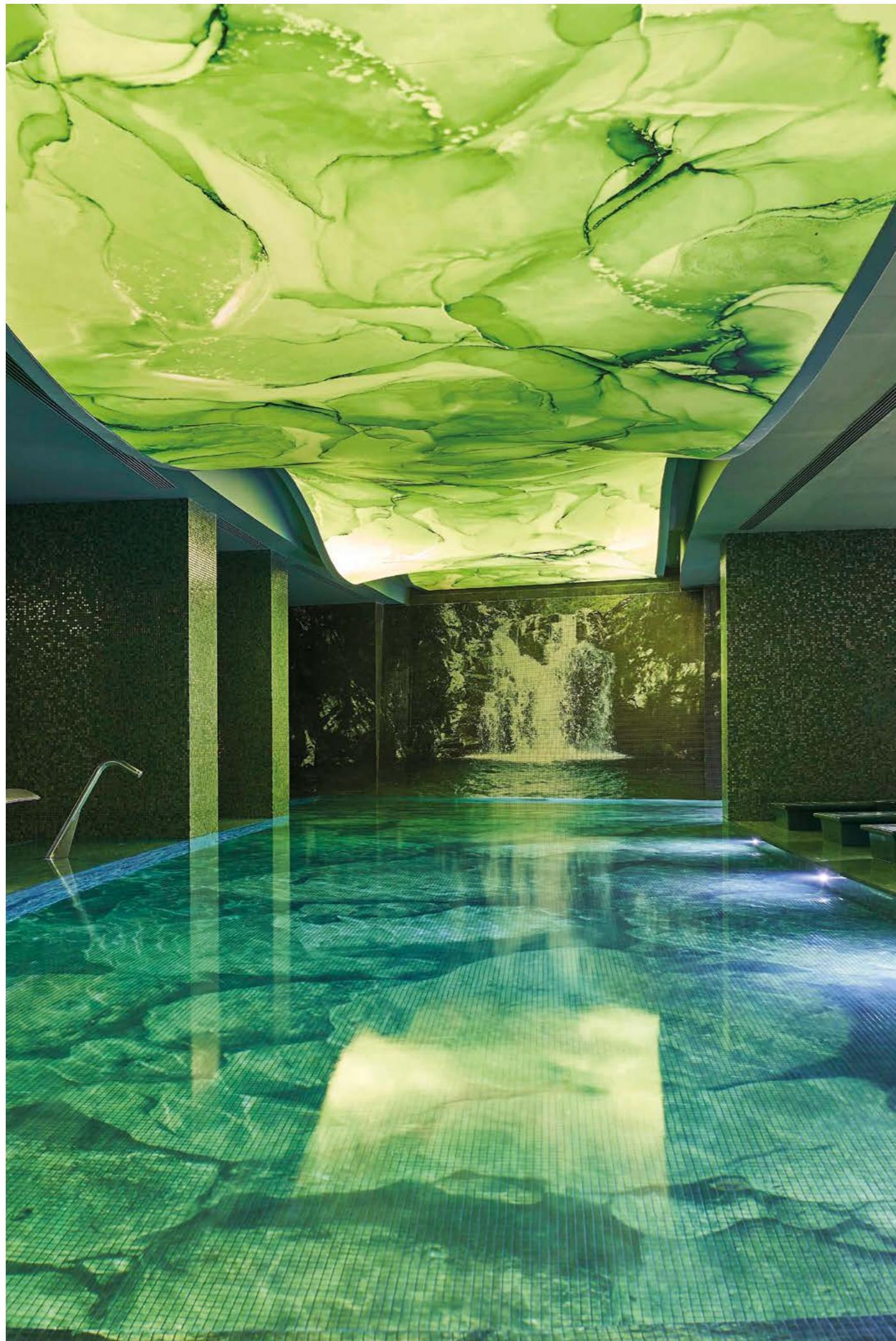

The Savoy Palace in Funchal has several swimming pools for guests to enjoy:

- The main pool, which has a wading pool for children, is at sea level.
- An infinity pool on the seventeenth floor called the Skypool.
- The VIP Lounge Pool, the jewel in the crown on another one of the terraces.
- The Wellness and Spa is located on the lower floor.
- And numerous private pools in the premium rooms. Highlights include the two Presidential Suites on the rooftop.

This means that 1,350 square metres of Ezarri's special combinations and designs were put into play. In addition, more than 360 m² of Custom Printed Mosaic completely cover the indoor wellness pool and waterfall. For the final bespoke touch, the hotel's rooftop pools were decorated with Custom Printed Mosaics: a moon for the Skypool and a huge jacaranda tree for the VIP Lounge Pool.

Added to the customised mosaics, other Ezarri products are also now part of the Savoy Palace Hotel in Funchal, including Lava, Óxido and Esmeralda, from the Metal collection, adding a glimmering metallic sheen.

El Hotel Savoy Palace en Funchal dispone de varias piscinas para disfrute de los clientes alojados en el establecimiento:

- La principal, que cuenta con una piscina infantil, se encuentra localizada a nivel del mar.
- También hay una piscina tipo infinity en el piso número diecisiete. Se trata de la Skypool.
- La VIP Lounge Pool como protagonista de otra de las terrazas que coronan el edificio.
- El Wellness y zona de Spa que se encuentra en la planta menos uno.
- A todas ellas hay que sumar numerosas piscinas privadas en las habitaciones de clase superior. Destacan las dos Suites Presidenciales enclavadas en la azotea del edificio.

Todo ello hace que, en datos, se hayan necesitado utilizar 1.350 metros cuadrados de mezclas especiales de Ezarri. Por otra parte, más de 360 m² de Custom Printed Mosaic que cubren por completo la piscina interior del wellness así como la cascada de agua que la corona. Para completar la customización del hotel, también se han decorado las piscinas de las azoteas utilizando Custom Printed Mosaics: una Luna para la Skypool y una enorme Jacaranda para la VIP Lounge Pool.

Además de los mosaicos personalizados, otras referencias de Ezarri también están presentes en el Hotel Savoy Palace de Funchal. Entre ellas Lava, Óxido y Esmeralda, de la colección Metal, con un acabado brillo metálico.

L'Hôtel Savoy Palace à Funchal dispose de plusieurs piscines pour les clients séjournant dans l'établissement :

- La principale, qui dispose d'un bassin pour enfants, est située au niveau de la mer.
- Il y a aussi une piscine Infinity (à débordement) au dix-septième étage : la Skypool.
- La VIP Lounge Pool protagoniste d'une autre des terrasses qui couronnent le bâtiment.
- L'espace Wellness et Spa qui se situe à l'étage moins un.
- A toutes, il faut ajouter de nombreuses piscines privées dans les chambres de classe supérieure. A noter les deux suites présidentielles situées sur le toit du bâtiment.

Tout cela signifie que, en parlant de données, il a été nécessaire d'utiliser 1 350 mètres carrés de mélanges spéciaux Ezarri. D'autre part, plus de 360 m² de Mosaïque Imprimée Sur Mesure qui recouvrent entièrement la piscine bien-être intérieure ainsi que la cascade qui la couronne. Pour compléter la personnalisation de l'hôtel, les piscines sur le toit ont également été décorées à l'aide de Mosaïques Imprimées Personnalisées : une Lune pour la Skypool et un immense Jacaranda pour la VIP Lounge Pool.

Outre les mosaïques personnalisées, d'autres références Ezarri sont également présentes au Savoy Palace Hotel de Funchal. Parmi elles, Lava, Óxido et Esmeralda, de la collection Metal, avec une finition métallique brillante.

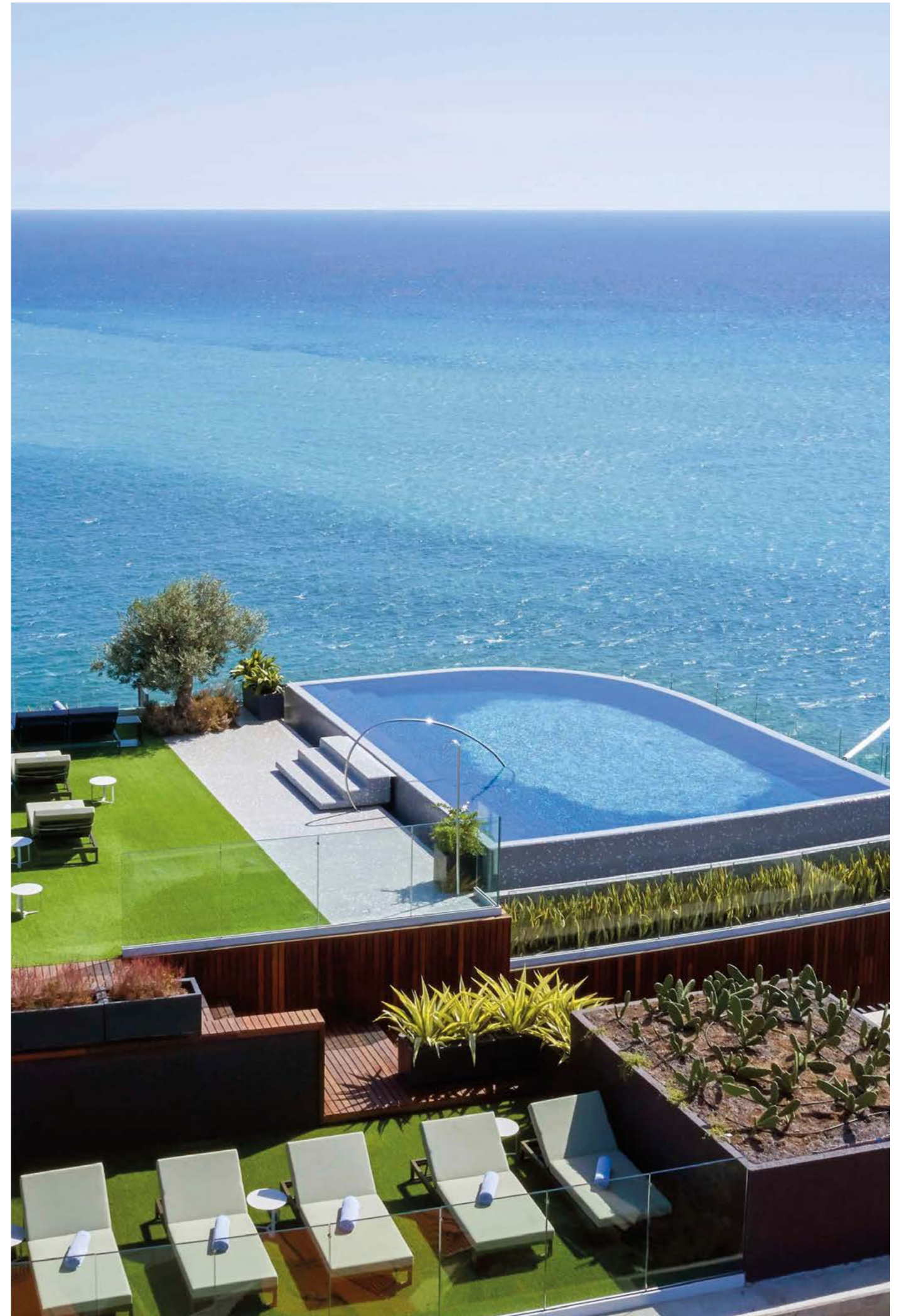

HUNGARY

CASE STUDY

Aquaticum Debrecen in Hungary

Debrecen has a population of 220,000 and is one of the most important cultural centres in Hungary. The University of Debrecen is one of its most emblematic institutions.

And now this grand leisure complex, in the forest bordering on the city, aims to become the symbol of Debrecen in the 21st century. It involves a combination of technology, materials, design and architecture with a strong environmental component dedicated to leisure and sports in which Ezarri's work stands out.

Representatives of Bord Studio, the company responsible for the project, explain the new concept they have developed for the Aquaticum water park in Debrecen. In their own words, "our concept for the Aquaticum water park in Debrecen doesn't involve competing with other aquatic facilities, but rather aims to create something new and unique."

The result is a proposal that is very different from the other spas in the country, with a surface area of water of 6,000 square metres.

Debrecen cuenta con 220.000 habitantes y es uno de los centros culturales más importantes del país húngaro. La Universidad de Debrecen es una de sus señas de identidad.

Además, este gran complejo de ocio, en el bosque que hay junto a esta ciudad, quiere convertirse en el símbolo de Debrecen en este siglo XXI. Es una suma de tecnología, materiales, diseño y arquitectura con un fuerte componente medioambiental dedicado al ocio y al deporte en el que el trabajo de Ezarri brilla con luz propia.

Bord Studio, los encargados del proyecto explican el nuevo concepto que han desarrollado en torno al parque acuático Aquaticum de Debrecen. En sus propias palabras, "nuestro concepto para el parque acuático Aquaticum de Debrecen no desea competir con otras instalaciones acuáticas, sino que aspira a crear algo nuevo y único".

El resultado es una apuesta realmente diferente a todos los demás spas del país, y cuenta con una superficie de agua de 6.000 metros cuadrados.

Debrecen compte 220.000 habitants et c'est un des centres culturels les plus importants du pays hongrois. L'Université de Debrecen est une de ses marques d'identité.

De plus, ce grand complexe de loisirs, situé dans la forêt qui se trouve juste à côté de cette ville, veut devenir le symbole de Debrecen du XXIème siècle. C'est un ensemble de technologie, matériaux, design et architecture avec un fort composant environnemental consacré aux loisirs et au sport dans lequel le travail d'Ezarri brille de tout son éclat.

Bord Studio, chargé du projet, explique le nouveau concept développé autour du parc aquatique Aquaticum de Debrecen. Reprenons leurs propres mots, "notre concept pour le parc aquatique Aquaticum de Debrecen n'est pas de faire la concurrence à d'autres installations aquatiques, mais d'aspirer à quelque chose de nouveau et d'unique".

Le résultat est un pari réellement différent de tous les autres spas du pays ; il comprend une surface d'eau de 6.000 mètres carrés.





A three-dimensional experience of water

For Bord Studio, the project became an exciting experiment. And they have succeeded in breaking with the traditional concepts of horizontal water park design by creating a three-dimensional experience.

The central visual attraction has the form of a bow with an east-west axis, with an area of 196 m x 26 m and a height of 12 m. It incorporates a variety of functions such as the thermal bath, the relaxation areas, the swimming pools and slides, and the solarium and the bars.

The project managers explain that "there are water walls twelve metres high with mirrors, waterfalls and veils of water. In this way the building offers a three-dimensional experience of water, and so both the permeability between the different levels and modules and the vertical and horizontal routes become part of a great adventure for users".

And for this to happen, all the latest Ezarri design and technology has been put at the service of the Aquaticum park in Debrecen.

Una experiencia tridimensional del agua

El proyecto se convirtió en un experimento apasionante para Bord Studio. Han logrado romper con los conceptos tradicionales de diseñar un parque acuático horizontal creando una experiencia tridimensional.

La atracción visual central es un eje de proa de este a oeste, de 196 m. x 26m. de piso y 12 m. de altura. Engloba varias funciones como el baño termal, las zonas de relax, las piscinas, los toboganes, el solarium y los bares.

Los responsables del proyecto explican que "hay muros de agua de doce metros de altura con espejos, cascadas y velos de agua. De esta forma el edificio ofrece una experiencia tridimensional del agua, y con ella, tanto la permeabilidad entre los diferentes niveles y módulos como los recorridos verticales y horizontales pasan a formar parte de una gran aventura para los usuarios".

Algo para lo que ha sido necesario aportar todo el diseño y la tecnología de Ezarri al servicio del parque Aquaticum de Debrecen.

Une expérience tridimensionnelle de l'eau

Le projet est devenu une expérience passionnante pour Bord Studio. Ils ont réussi à marquer une rupture avec les concepts traditionnels de design d'un parc aquatique horizontal en créant une expérience tridimensionnelle.

L'attraction visuelle centrale est un axe de proue de l'est à l'ouest, de 196 m. x 26m. au sol et 12 m. de hauteur. Il englobe plusieurs fonctions comme le bain thermal, les zones de détente, les piscines, les tobogans, le solarium et les bars.

Les responsables du projet expliquent qu'"il y a des murs d'eau de douze mètres de haut avec des miroirs, des cascades et des voiles d'eau. De cette manière, le bâtiment offre une expérience tridimensionnelle de l'eau, et avec elle, autant la perméabilité entre les différents niveaux et modules que les parcours verticaux et horizontaux deviennent une grande aventure pour les utilisateurs".

C'est pourquoi Ezarri a apporté au service du parc Aquaticum de Debrecen tout le design et la technologie nécessaires à ce projet.





Ezarri has played a leading role in the creation of the Aquaticum water park. Both the wall and the basin of the outdoor pool, the pool beaches and also the children's pools have been tiled with Ezarri mosaic.

For this tremendous undertaking, Bord Studio has used a combination of Ezarri collection colours:

For the wall they chose the reference 2596-b from the Niebla collection. This is a glass mosaic tile in misty colours, particularly suitable for the lining of interiors, swimming pools, spas, saunas and wellness spaces.

For the basin of the outdoor pool, Bord Studio chose the reference 2518-b, from the Mix collection. These are mixtures of colours from the Niebla collection, which provide the most exquisite combinations. In the area of the children's pools, shallow enough to walk in, the Ezarri 2518-b SAFE reference has been installed. And also for the pool beaches, located in the outdoor areas.

The other style references used are:

- 2521-B Safe
- 2596-B Safe
- 2545-A Safe
- 2596-B
- 2521-B

Ezarri ha tenido un papel principal en el parque acuático Aquaticum. Se ha recubierto con mosaico de Ezarri tanto la pared como el vaso de la piscina exterior, las playas de la piscina y también las piscinas infantiles.

Para todo este tremendo esfuerzo, Bord Studio ha utilizado una combinación de referencias de Ezarri:

Para la pared se ha optado por la referencia 2596-b de la colección Niebla. Se trata de un mosaico en colores brumosos especialmente indicado para revestimiento de interiores, piscinas, spas, saunas y espacios wellness.

Para el vaso de la piscina exterior, Bord Studio ha optado por la referencia 2518-b, de la colección Mix. Son mezclas de colores de la colección Niebla, que proporcionan las combinaciones más exquisitas. La zona de las piscinas infantiles, donde apenas cubre, está instalado la referencia 2518-b SAFE de Ezarri. Y también las playas de la piscina, situadas en las zonas exteriores.

El resto de referencias utilizadas son:

- 2521-B Safe
- 2596-B Safe
- 2545-A Safe
- 2596-B
- 2521-B

Ezarri a joué un rôle essentiel dans le parc aquatique Aquaticum. La mosaïque d'Ezarri revêt les murs et le bassin de la piscine extérieure, les plages de la piscine ainsi que les piscines pour enfants.

Pour tout ce grand effort, Bord Studio a utilisé une combinaison de références d'Ezarri :

Pour le mur, il a opté pour la référence 2596-b de la collection Niebla. Il s'agit d'une mosaïque aux couleurs brumeuses spécialement recommandé pour le revêtement d'intérieurs, de piscines, de spas, de saunas et d'espaces de bien-être.

Pour le bassin de la piscine extérieure, Bord Studio a opté pour la référence 2518-b, de la collection Mix. Ce sont des mélanges de couleurs de la collection Niebla, qui offrent les combinaisons les plus exquis. Pour la zone de piscines pour enfants, la référence 2518-b SAFE de Ezarri a été choisie. Mais aussi pour les plages de piscine, situées sur les zones extérieures.

Le reste des références utilisées sont :

- 2521-B Safe
- 2596-B Safe
- 2545-A Safe
- 2596-B
- 2521-B

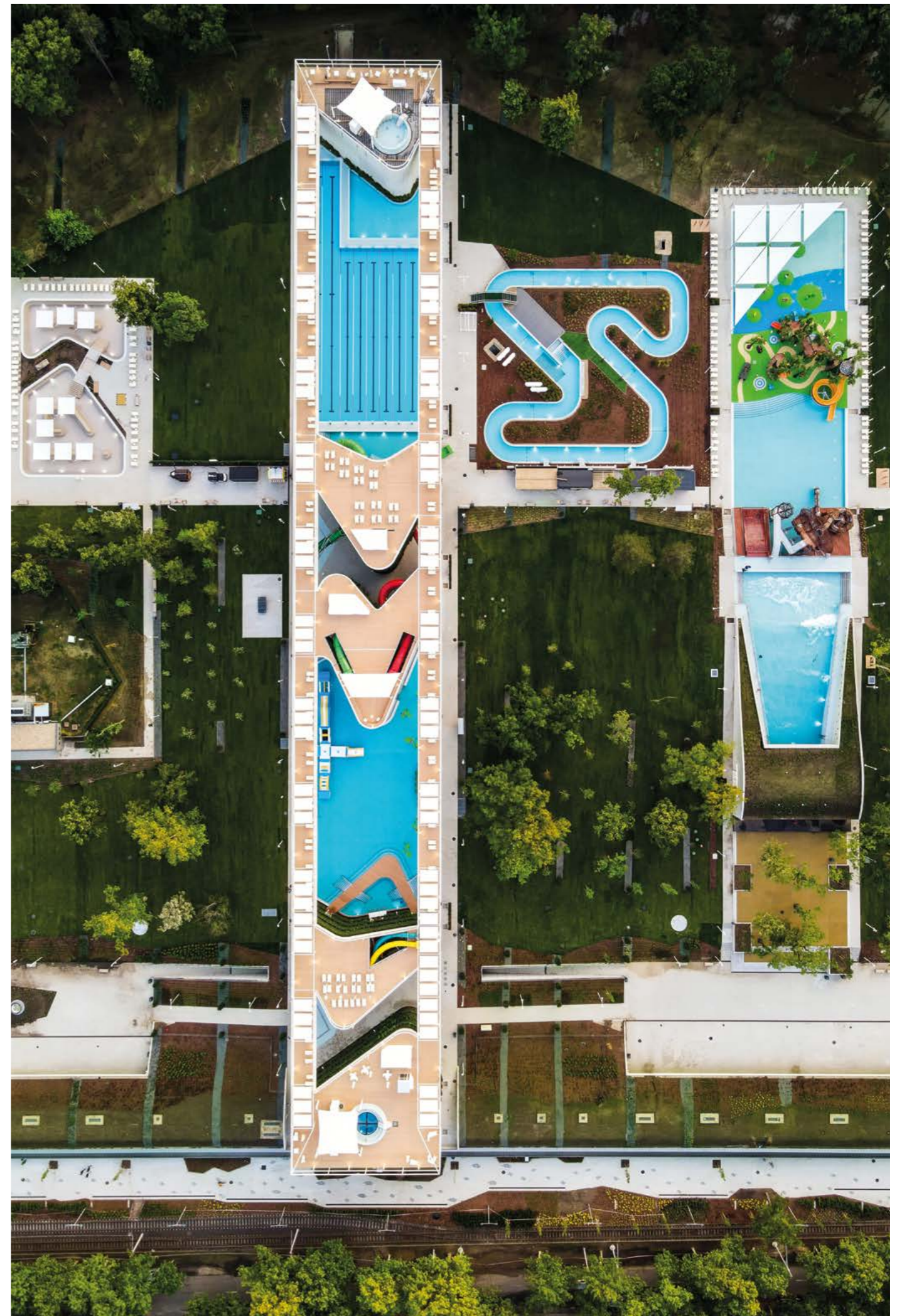

ROMANIA

CASE STUDY

Unirii Square Fountains in Bucharest

The objective was to use glass mosaic tiles to rehabilitate the fountains that begin at the Palace of the Parliament and run along a boulevard in the centre of the Romanian capital. And the project was carried out to celebrate the centenary of the unification of the country, which took place in 1918.

It involved an ensemble of 44 independent fountains built in the late 1980s. The system of fountains covers a distance of 1.4 kilometres in front of the Palace of the Parliament, the largest administrative building in the world.

Ezarri has therefore used glass mosaic tiles to cover the largest system of fountains in the world, located in Bucharest. The system offers a choreography of light, colour, water and sound in a multimedia show unparalleled in the world.

El objetivo que se perseguía era rehabilitar con mosaico las olvidadas fuentes que nacen del Palacio del Parlamento y atraviesan un bulevar en el centro de la capital de Rumanía. Y se ha realizado con motivo del centenario de la unificación del país, que tuvo lugar en 1918.

Se trata de un conjunto de 44 fuentes independientes construidas a finales de la década de 1980. El sistema de fuentes cubre una distancia de 1,4 kilómetros alrededor del Palacio del Parlamento, el edificio administrativo más grande del mundo.

De este modo, Ezarri ha revestido con mosaico de vidrio el mayor sistema de fuentes del mundo, que está en Bucarest. El sistema ofrece una coreografía de luz, color, agua y sonido en un espectáculo multimedia sin parangón en el mundo.

L'objectif poursuivi consistait à restaurer avec la pâte de verre les fontaines qui naissent du Palais du Parlement et traversent un boulevard dans le centre de la capitale de Roumanie. Et cela a été chose faite à l'occasion du centenaire de l'unification du pays, qui a eu lieu en 1918.

Il s'agit d'un ensemble de 44 fontaines indépendantes construites à la fin des années 1980. Le système de fontaines recouvre une distance de 1,4 kilomètre autour du Palais du Parlement, le plus grand bâtiment administratif au monde.

Ainsi, Ezarri a revêtu de mosaïque le plus important système de fontaines au monde, qui se trouve à Bucarest. Le système offre une chorégraphie de lumière, de couleur, d'eau et de son dans un spectacle multimédia unique au monde.

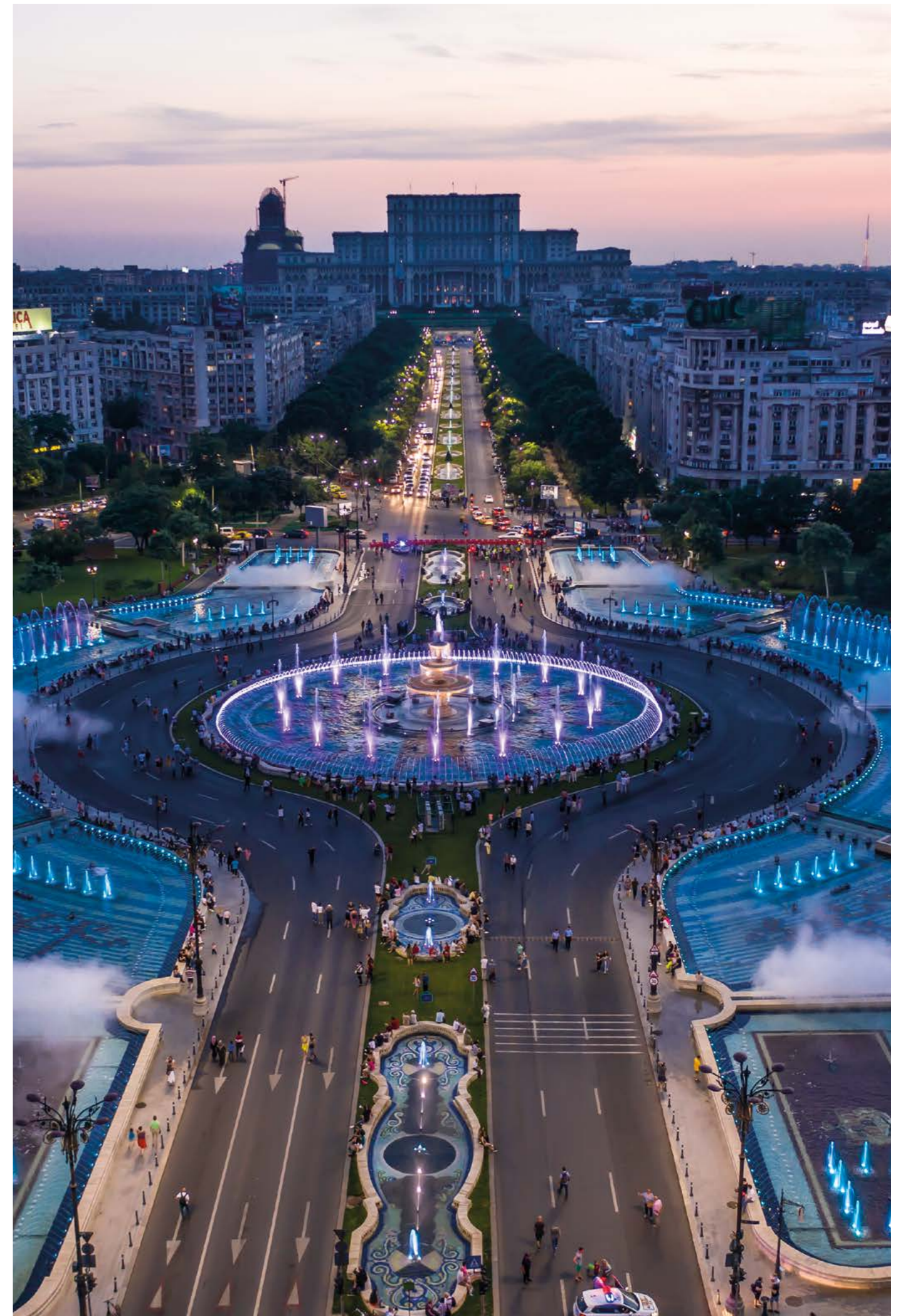

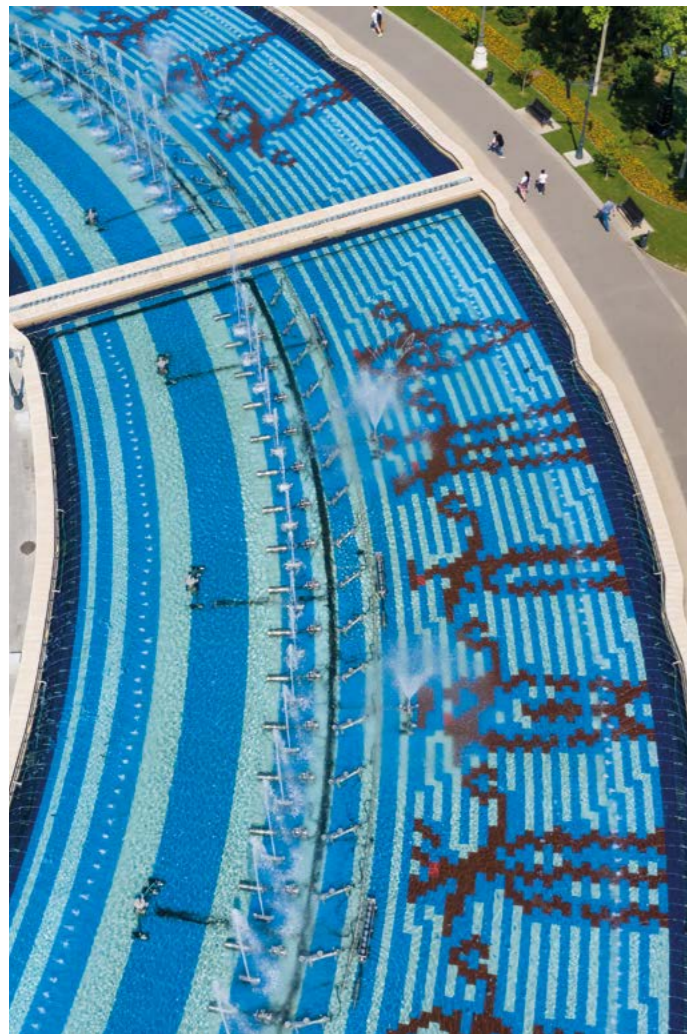

The system of fountains has extraordinary dimensions. The figures relating to the project speak for themselves:

- 10.200 square metres.
- 44 independent fountains.
- 1,4 kilometres.
- 4 months for the implementation.

That explains why they came to Ezarri, the company which offered the best range of glass mosaic tiles for a unique installation in terms of its dimensions and which was able to complete the challenge of finishing the project in a record time of four months.

These fountains covered with glass mosaic tiles by Ezarri offer a new perspective on the city, in a multimedia choreography that has become the main tourist attraction. Not surprisingly, the show attracts thousands of tourists.

El sistema de fuentes tiene unas dimensiones apabullantes. Las cifras que se manejaban para encarar el proyecto son las siguientes:

- 10.200 metros cuadrados.
- 44 fuentes independientes.
- 1,4 kilómetros.
- 4 meses de realización.

Es entonces cuando se recurrió a Ezarri, que ofrecía la mejor gama de mosaico de vidrio para una instalación única en sus dimensiones y que permitió completar el reto de terminar el proyecto en el plazo récord de cuatro meses.

Estas fuentes revestidas con mosaico vítreo por Ezarri ofrecen una nueva perspectiva sobre la ciudad, en una coreografía multimedia que se ha convertido en el principal atractivo turístico. No en vano, atrae a miles de turistas durante el espectáculo.

Le système de fontaines a des dimensions impressionnantes. Les chiffres manipulés pour diriger le projet sont les suivants :

- 10.200 mètres carrés.
- 44 fontaines indépendantes.
- 1,4 kilomètres.
- 4 mois de réalisation.

C'est là que l'on a fait appel à Ezarri, qui offrait la meilleure gamme de pâte de verre pour une installation unique dans ses dimensions et qui a permis de réaliser le défi consistant à terminer le projet dans le délai record de quatre mois.

Ces fontaines revêtues de mosaïque par Ezarri offrent un nouveau point de vue sur la ville, dans une chorégraphie multimédia qui est devenue le principal attrait touristique. Ce n'est pas un hasard si elle attire des milliers de touristes durant le spectacle.

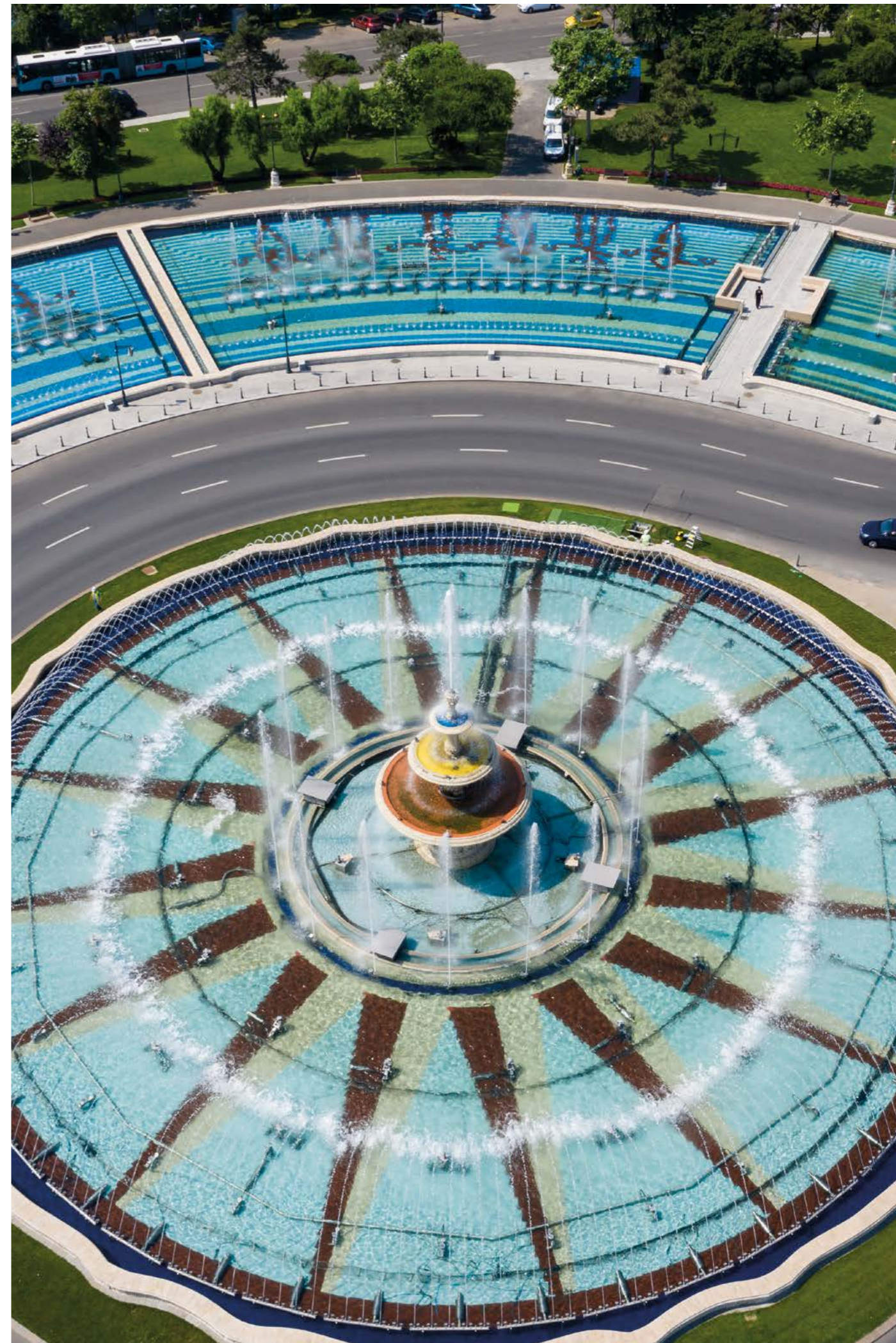



In addition, Ezarri has printed glass mosaic tiles to create various coats of arms belonging to the Kings of Romania. They belong to the monarchs who participated in the unification of the country. The ensemble of fountains offers a unique night-time multimedia show. And during the day it shines brilliantly with the mosaic with which Ezarri has covered it.

The coats of arms of the Royal House of Romania created using digital printing on glass mosaic tiles (Custom Printed Mosaic) by Ezarri have been arranged in pairs along the central axis of the boulevard. They cover a surface area of more than one hundred square metres and as the fountains have been redesigned to commemorate the first centenary of the unification of Romania, they also remember the Royal House.

It is here that the full potential of the Ezarri digital mosaic printing is revealed. And it is not only because of the print quality, but also because of the colours and the high definition achieved. The glass mosaic tiles with these heraldic motifs give a profound historical meaning to the Bucharest Fountains project.

And following their inauguration just over a year ago, the fountains in Unirii Square covered by Ezarri with glass mosaic tiles have already become a symbol of the city and a major tourist attraction for the Romanian capital.

Además, Ezarri ha realizado con mosaico impreso varios escudos pertenecientes a los Reyes de Rumania. Son aquellos que participaron en la unificación del país. Se trata, en suma, de un conjunto que es un espectáculo multimedia único de noche. Pero que, durante el día resplandece con el mosaico con que Ezarri lo ha revestido.

Los escudos de la Casa de Rumanía realizados en impresión digital en mosaico de vidrio (Custom Printed Mosaic) por Ezarri se han dispuesto por parejas a lo largo del eje del bulevar. Escudos que ocupan más de cien metros cuadrados de superficie y al tratarse de unas fuentes rediseñadas para conmemorar el primer centenario de la unificación de Rumanía, no podían olvidar a la Casa Real.

Es aquí donde la impresión digital en mosaico de Ezarri revela toda su potencia. No sólo por la calidad de la impresión. También por los colores y la alta definición conseguida. El mosaico vitreo con estos motivos heráldicos dan completo sentido histórico al proyecto de las Fuentes de Bucarest.

Así, hace algo más de un año, se inauguraron las fuentes en la plaza Unirii, revestidas con mosaico por Ezarri y ya han conseguido convertirse en un símbolo de la ciudad y en un polo de atracción turística de la capital rumana.

De plus, Ezarri a réalisé avec mosaïque imprimé plusieurs blasons appartenant aux Rois de Roumanie. Ce sont eux qui ont participé à l'unification du pays. En somme, cet ensemble est un spectacle multimédia unique de nuit. Mais qui, pendant la journée, resplendit avec la mosaïque avec laquelle Ezarri l'a revêtu.

Les blasons de la Maison de Roumaine en impression numérique en pâte de verre (Custom Printed Mosaic) par Ezarri ont été disposés par couples le long de l'axe du boulevard. Des blasons qui occupent plus de cent mètres carrés de surface et, s'agissant de fontaines reconçues pour commémorer le premier centenaire de l'unification de Roumanie, ne pouvaient pas oublier la Maison Royale.

C'est là que l'impression numérique en mosaïque d'Ezarri révèle toute sa puissance. Non seulement pour la qualité d'impression, mais également pour les couleurs et la haute définition obtenue. La pâte de verre avec ces motifs héraldiques donne un sens historique complet au projet des Fontaines de Bucarest.

Ainsi, cela fait un peu plus d'un an que les fontaines sur la place Unirii, revêtues de pâte de verre par Ezarri, ont été inaugurées et sont devenues un symbole de la ville et un pôle d'attraction touristique de la capitale roumaine.

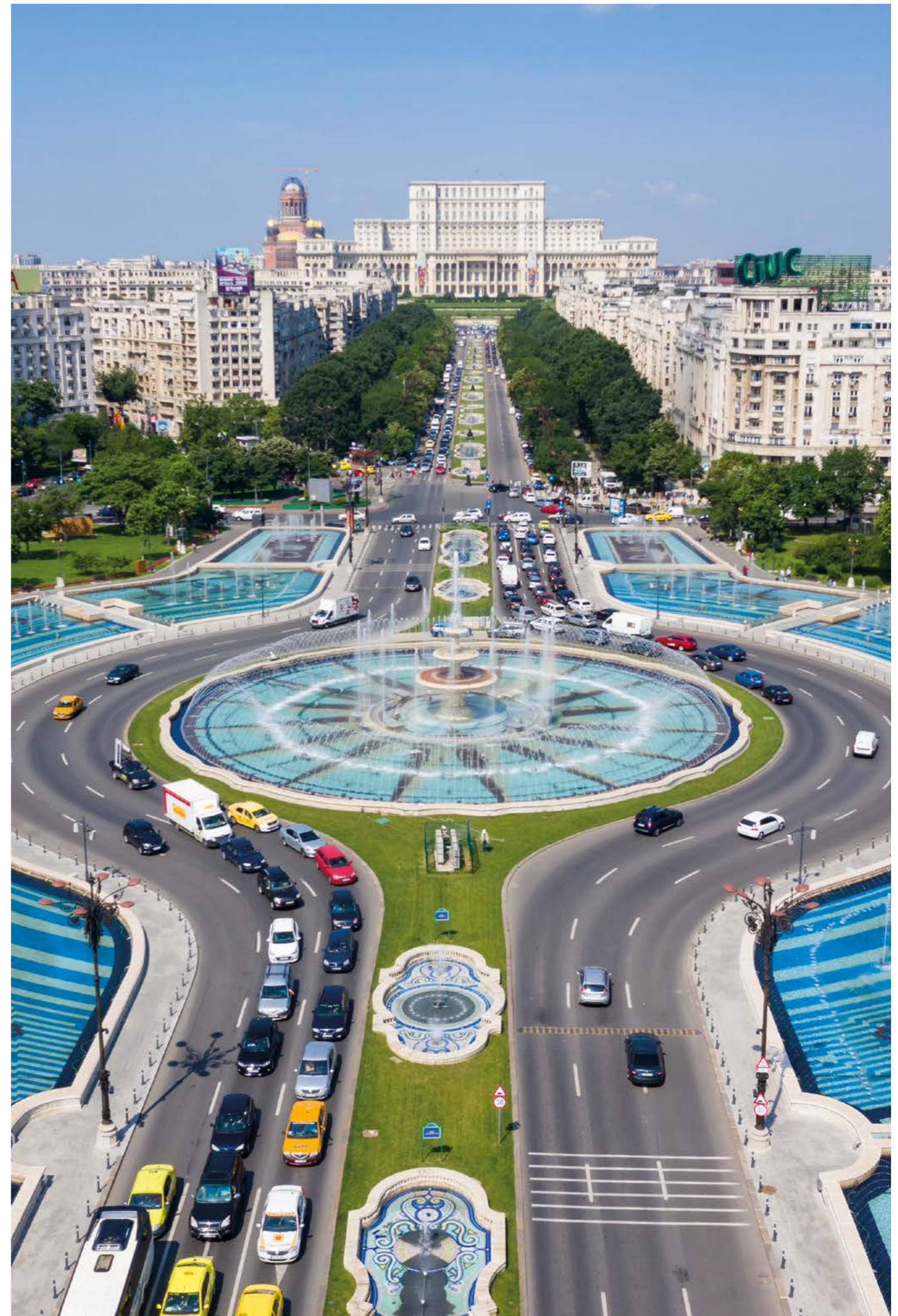

PARIS

CASE STUDY

Serpentin

20.000 m² Ezarri Façade.

Specialized in manufacturing glass mosaics, Ezarri has been involved in the refurbishment of the Serpentin building at the Courtillières area in Panting, next to Paris. Ezarri has supplied 20.000 m² from different mosaic colour ranges to generate a fade out effect on this very impressive and emblematic building.

This is an immense façade of 2km length, and the refurbishment has been organized in various phases. This exceptional rehabilitation project was carried out in several stages over 14 years, due to its huge size.

Más de 20.000 m² de fachada revestida por Ezarri.

Especializados en la fabricación y distribución de mosaico de vidrio, Ezarri ha participado en la rehabilitación del edificio Serpentin en el barrio de Courtillières en Pantin, junto a Paris. Seleccionado entre una gran cantidad de revestimientos, Ezarri ha suministrado más de 20.000 m² de distintos mosaicos para generar un efecto de degradado de colores en este impresionante y emblemático edificio.

Se trata de una inmensa fachada de unos 2 km de longitud, cuya rehabilitación se ha organizado en distintas fases. Esta excepcional obra de rehabilitación ha sido realizada en varias etapas, a lo largo de 14 años, debido a la magnitud del proyecto.

20.000 m² de façade réalisés en émaux de verre Ezarri.

Spécialisé dans la fabrication et la distribution d'émaux de verre, Ezarri a participé à la réhabilitation du bâtiment Le Serpentin dans la Cité des Courtillières à Pantin, à côté de Paris.

Sélectionné parmi un grand nombre de revêtements, Ezarri a fourni 20.000 m² de mosaïques pour la réalisation d'un dégradé de couleurs sur cet impressionnant et emblématique édifice.

Il s'agit d'une immense façade de près de 2 kms de long dont la réhabilitation s'est déroulée en plusieurs étapes. Cet exceptionnel chantier de réhabilitation a été exécuté en plusieurs étapes, durant 14 années, compte tenu de l'ampleur du projet.

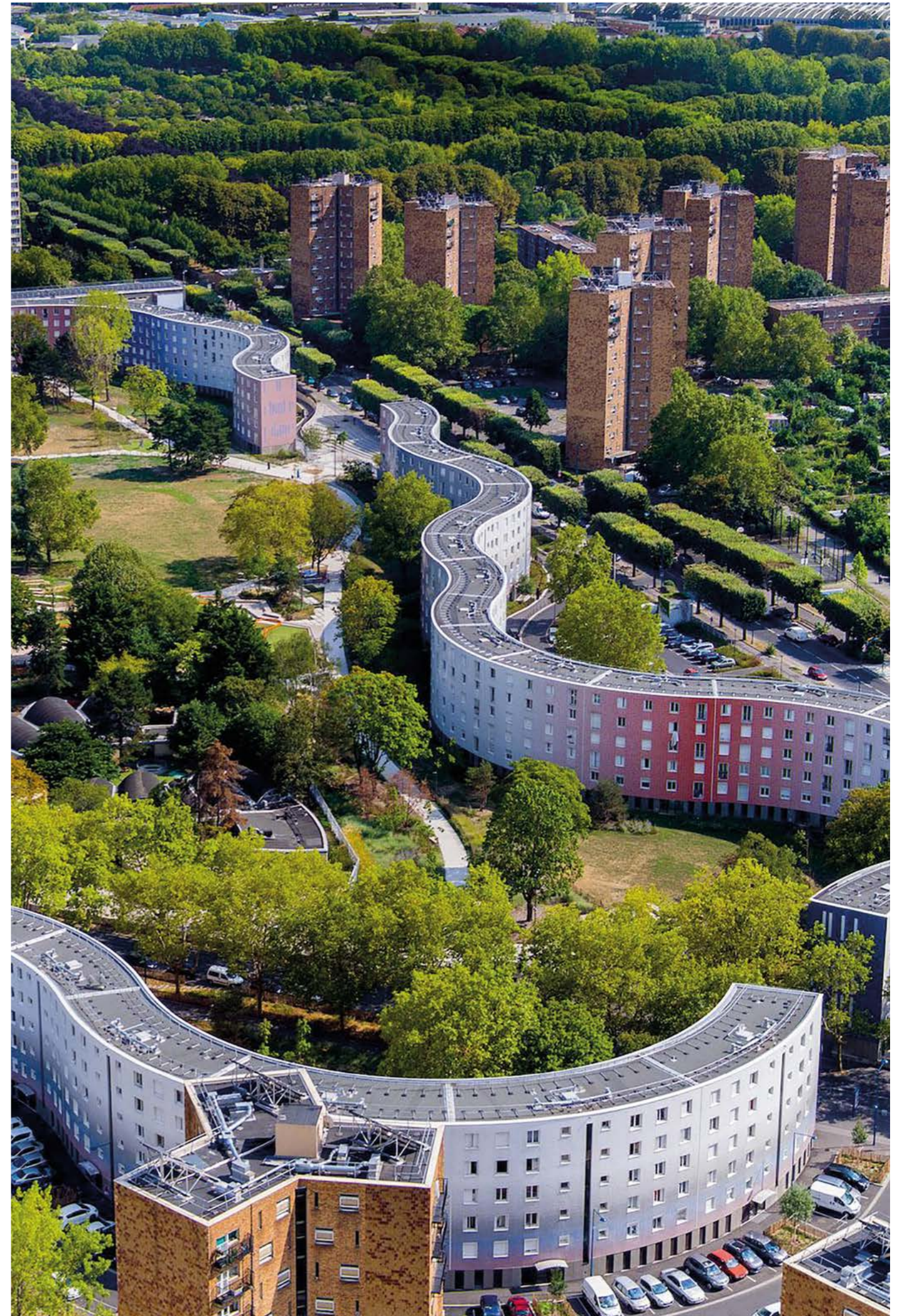

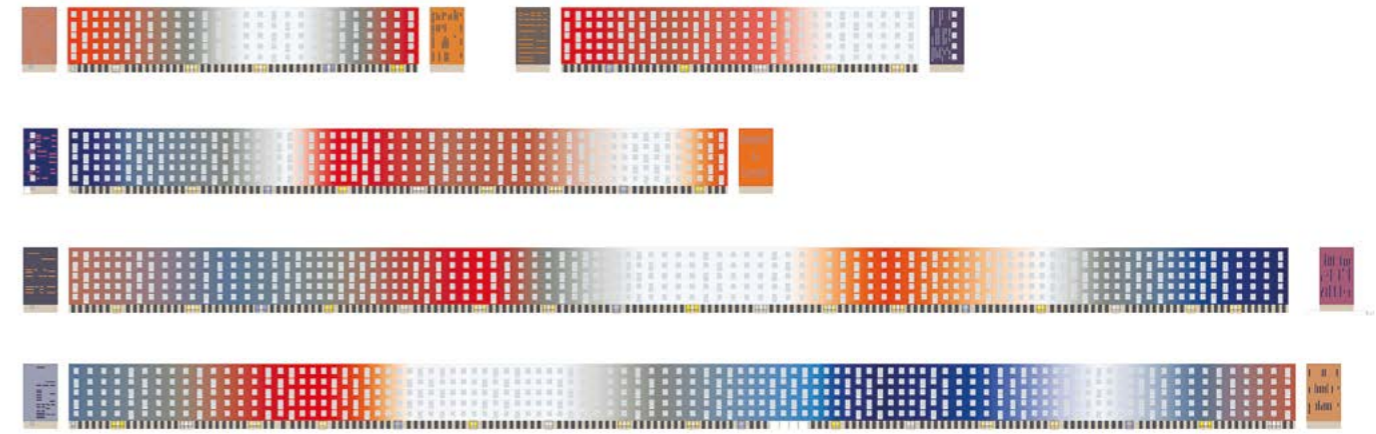

History

This project was granted to Émile Aillaud in the fifties at the Courtilières, in Pantin. The brief was to fit in 630 flats in two buildings around a four Hectares Park with a circular shape.

It is the second biggest building in Europe and a 20th Century Heritage Listed.

The first refurbishment was done in the 80s. The balconies were taken away due to deep deterioration created by corrosion and the exterior insulation was made.

By the end of the 20th century, the general deterioration of the property was significant, even the Town Hall got involved in improving the neighbourhood's life conditions. The decision was made to renovate the façade completely and to improve on security and traffic, creating new access to the park.

In the year 2000 the Town Hall and the Public Housing Office in Pantin started the renovation project, and after 14 years is now being finalized.

The Architecture Cabinet RVA (Dominique Reanud and Philippe Vignaud Associates), after getting the tender, they started the refurbishment together with the construction company GTM Bâtiment. The whole project and the works have always been under Pantin Habitat and the Culture Ministry's supervision.

The brief was clear – to introduce a better social accommodation, upgrading it to the population's expectations, but keeping the architectural structure. With this in mind, as well as the façade's refurbishment, 5 modules were demolished to improve the park access, giving a new appearance and life to the park.

Historia

Este proyecto fue concebido por el célebre arquitecto Émile Aillaud en los años 50 en el barrio de Courtilières, en Pantin, para dar cabida a 630 pisos en dos edificios con una forma ondulada que rodean un parque de 4 hectáreas.

Es el segundo edificio más grande de Europa y está catalogado como "Patrimonio del siglo XX".

En los años 80 se realizó la primera restauración: fueron retirados los balcones ya que la corrosión los había deteriorado profundamente y se realizó el aislamiento exterior del edificio.

Para finales del siglo XX, el deterioro general del inmueble era significativo, hasta tal punto que el propio ayuntamiento de la ciudad se involucra para renovar y mejorar las condiciones de vida de sus habitantes: se decide renovar completamente la fachada así como mejorar la circulación y la seguridad creando nuevos accesos al parque interior.

En el año 2000 el ayuntamiento junto con Oficina de la Vivienda Pública de Pantin comenzaron un proyecto de renovación que después de 14 años está llegando a su conclusión.

El gabinete de arquitectura RVA (Dominique Renaud y Philippe Vignaud Asociados), tras ganar un concurso público, empezó los trabajos de rehabilitación junto con la empresa de construcción GTM Bâtiment. Todo el proyecto y las obras han estado siempre bajo la supervisión de Pantin Habitat y el ministerio de Cultura.

La rehabilitación tenía un objetivo claro: "reintroducir las condiciones favorables de alojamiento social, acondicionándolo a los modos de vida y las expectativas de sus habitantes, todo ello siendo respetuosos con la obra arquitectónica". Con estas consideraciones, además de la profunda rehabilitación de la fachada, 5 módulos fueron demolidos para mejorar los accesos al parque interior, dando una nueva apariencia y vida al parque.

Histoire

Ce projet a été conçu par le célèbre architecte Emile Aillaud dans les années 1950 dans la Cité des Courtilières à Pantin pour créer 630 logements dans 2 édifices ayant une forme ondulée et qui ceinturent un parc de 4 hectares.

C'est le deuxième édifice le plus grand d'Europe et il est classé « Patrimoine du XX^e siècle ».

La première restauration a été réalisée dans les années 1980 : les balcons furent retirés car la corrosion les avait profondément détériorés et l'étanchéité extérieure de l'édifice a été refaite.

A la fin du XX^e siècle, la détérioration générale de l'immeuble était tellement significative que la Mairie de la ville s'est investie pour rénover et améliorer les conditions de vie de ses habitants ; il a été décidé la rénovation complète de la façade ainsi que l'amélioration de la circulation et de la sécurité en créant de nouveaux accès au parc intérieur.

En l'an 2000, la Mairie et l'Office Public de l'Habitat de Pantin ont lancé un projet de rénovation qui, après 14 années, arrive à son terme.

Le cabinet d'architecture RVA (Dominique Renaud y Philippe Vignaud Associés) qui a remporté le concours public, a commencé les travaux de réhabilitation avec l'entreprise de constructions GTM Bâtiment. L'intégralité du projet et des travaux ont été supervisés par Pantin Habitat et le Ministère de la Culture.

La réhabilitation avait un objectif clair, « réintroduire les conditions favorables au logement social, en les adaptant aux modes de vie et aux attentes de ses habitants et en étant respectueux de l'œuvre architecturale. » Sur la base de ces considérations, en plus de la profonde réhabilitation de la façade, 5 modules furent détruits pour améliorer les accès au parc intérieur, donnant une nouvelle apparence et une nouvelle vie au parc.

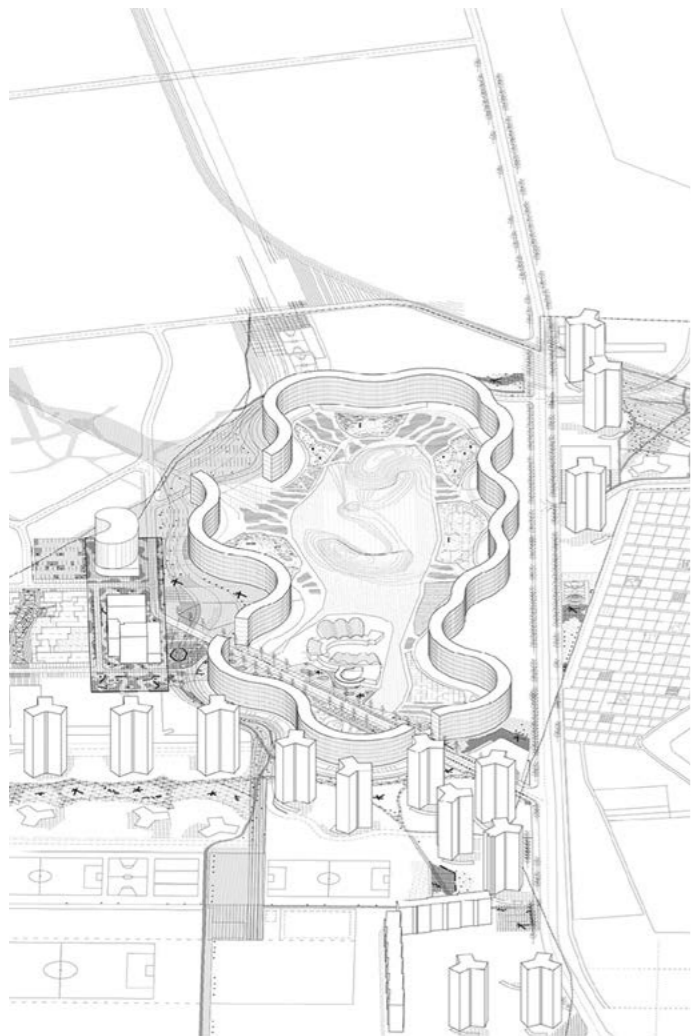

Wellness

Castellum Hotel Hollókő

HOLLOKO, HUNGARY

RENOVATION

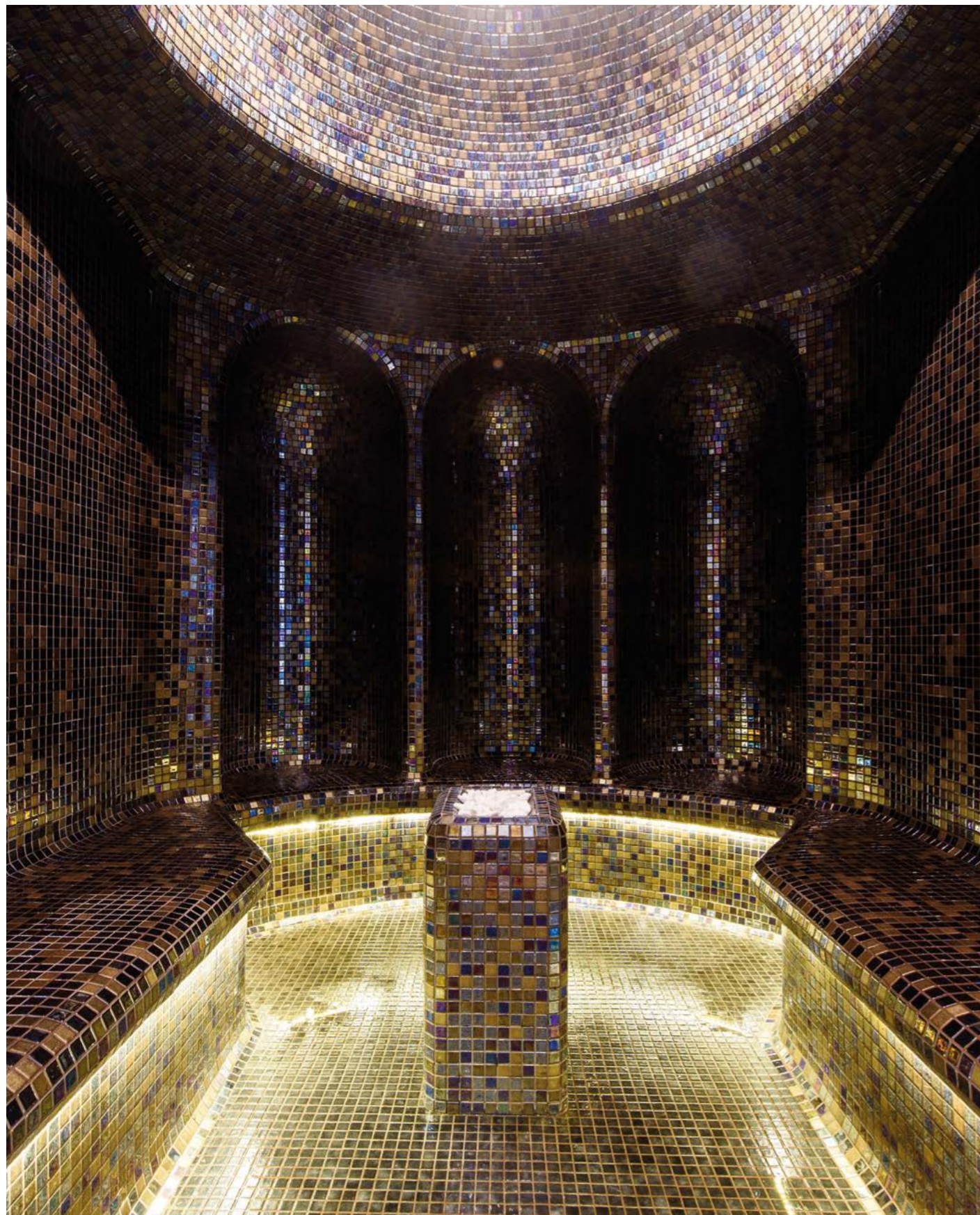

Pleasant atmosphere on the adventure pools and the relaxation of the jacuzzi and Sauna.

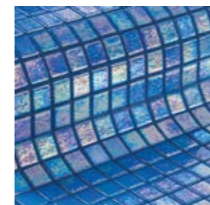

Ocean

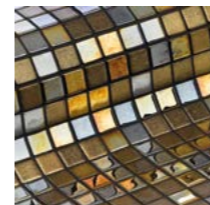

Alexander

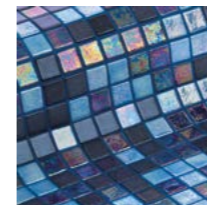

Blue Lagoon

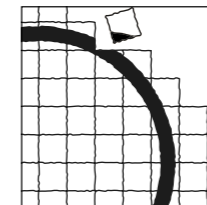

Custom Printed



La Cigale Tabarka Hotel

Ideally located near the charming historic village of Tabarka, on the superb North-West coastline of Tunisia, this is a magic place where refined luxury, traditional hospitality, and lush greenery mix together. Fusion between a modern style and an oriental flair, all interior pools and Spa area mosaic are the best proof of it.

TABARKA, TUNISIA

FAKHER TURKI

NEW CONSTRUCTION

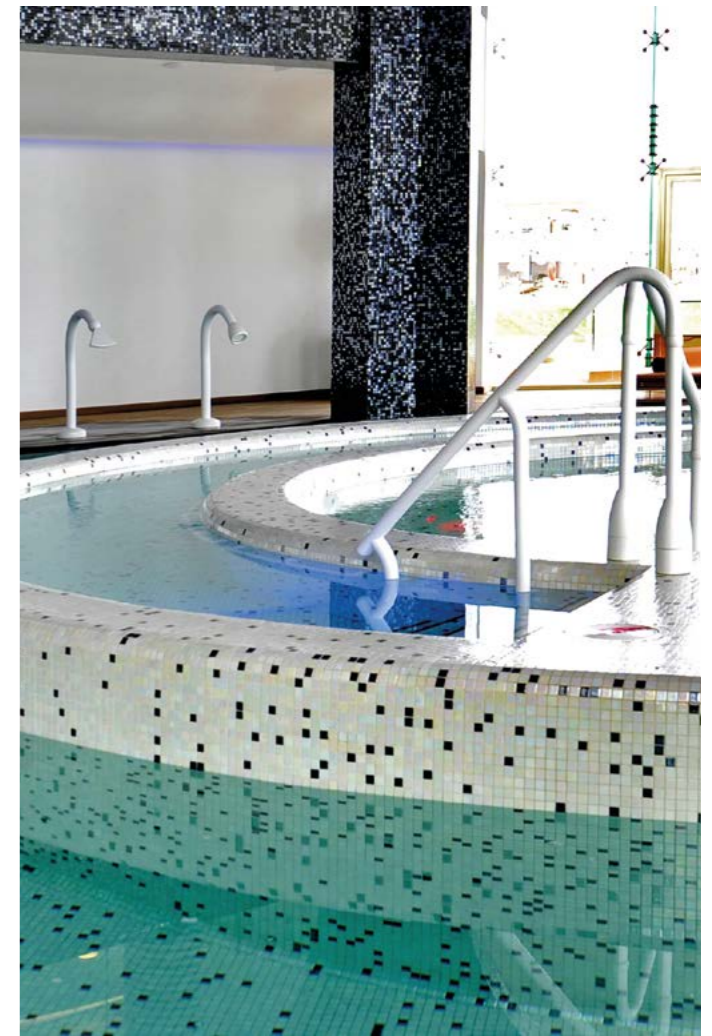

Lava

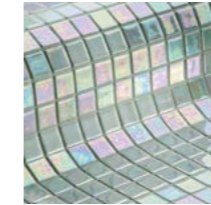

Perla

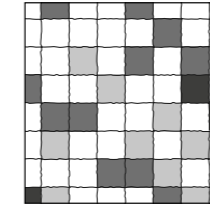

Custom Mix

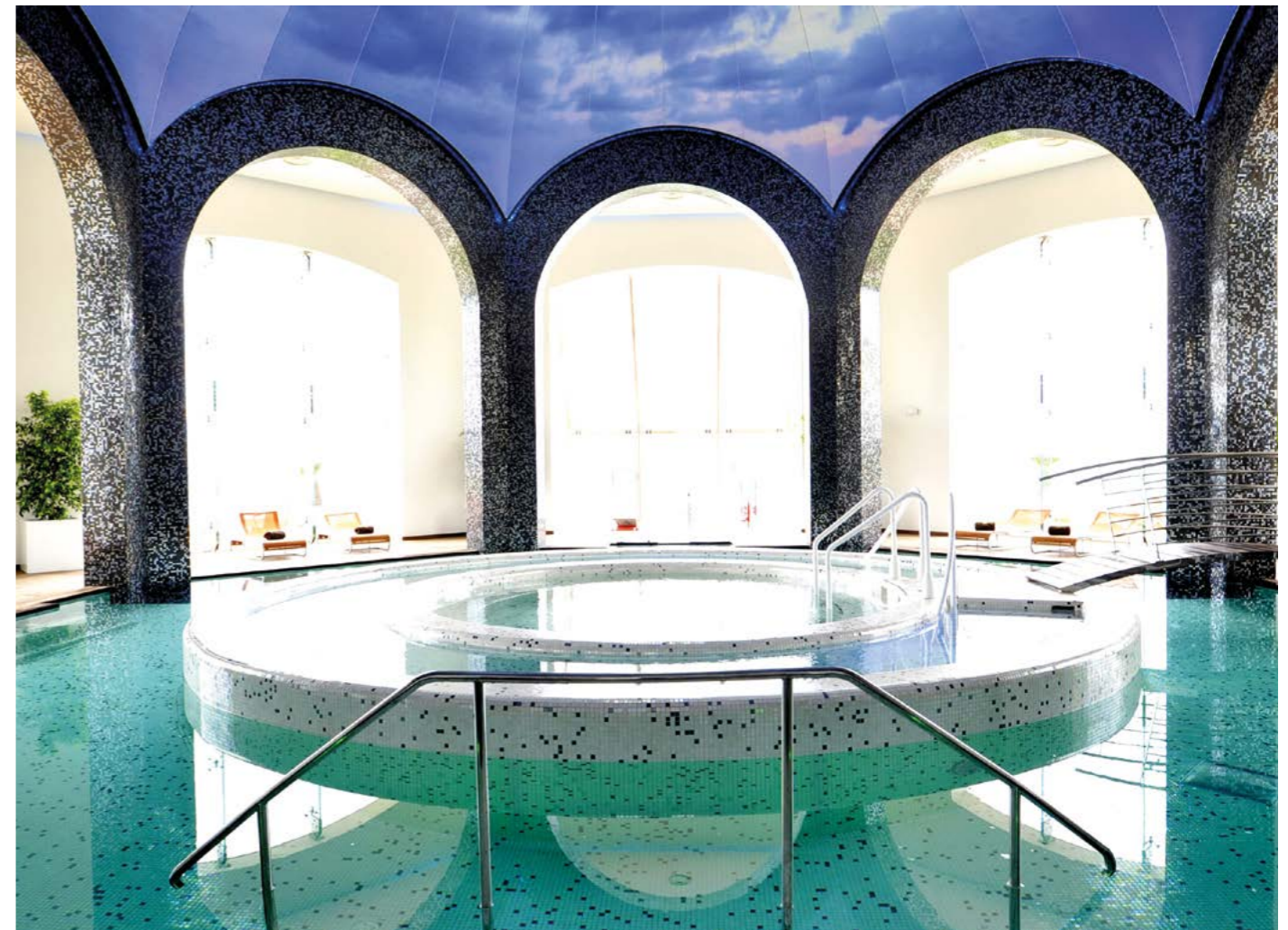

Banya Wellness & Spa

PODGORICA, MONTENEGRO

NEW CONSTRUCTION

This Wellness & Spa Center offers complete health and spa services and it's equipped with a pool, a steam bath, a salt room, saunas, relaxation showers, and tepidarium, where you may relax and feel like you are miles away from the contemporary world, the crowds, and everyday stress. This oasis of beneficial warmth, detoxication, and relaxation will help you relax your senses completely, improving both your immunity and your mood. The owner himself selected from the wide range of Ezarri mosaics for all areas.

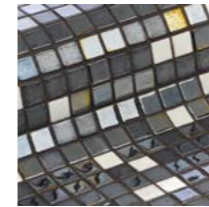
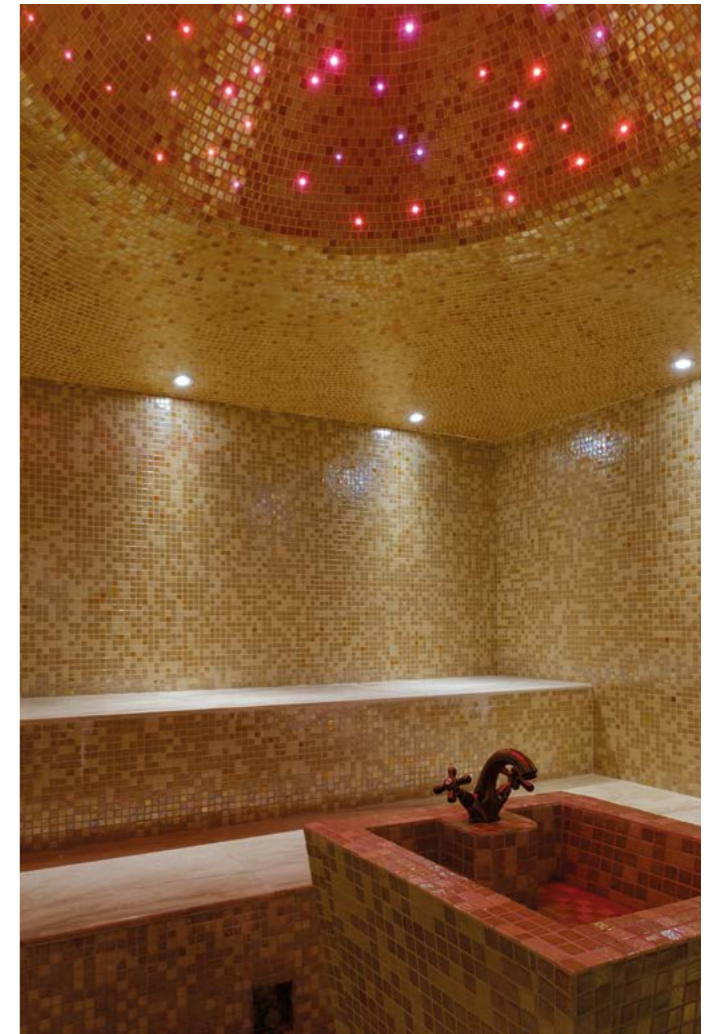

San Francisco

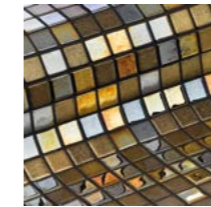

Alexander

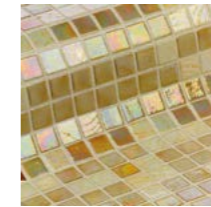

Bellini



Stary Zdrój Altes Kurhaus Hotel

ŚWIERADÓW-ZDRÓJ, POLAND

POLISH CONSERVATOR
OF MONUMENTS

RENOVATION

Stary Zdrój, the former Baths of Count Ludwik ("Ludwigsbad") from 1878, were thoroughly renovated, modernized, and expanded in 2012, selecting Ezarri mosaics white (2545-A) and black (2530-D) colours to create incredible spaces.

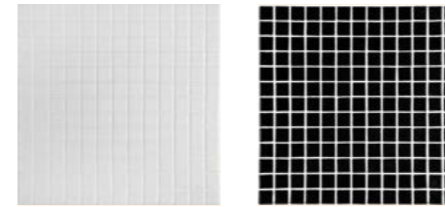

2545-A

2530-D



Midalidare Hotel & Spa

MOGILOVO, BULGARIA

AQUATEC

RENOVATION



Find a variety of wellness services, the spa center has a heated indoor pool, Jacuzzi and bar, as well as an infrared, Finnish and herbal sauna, Roman bath and hammam.

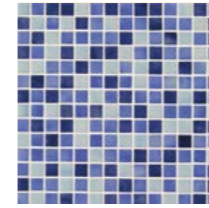
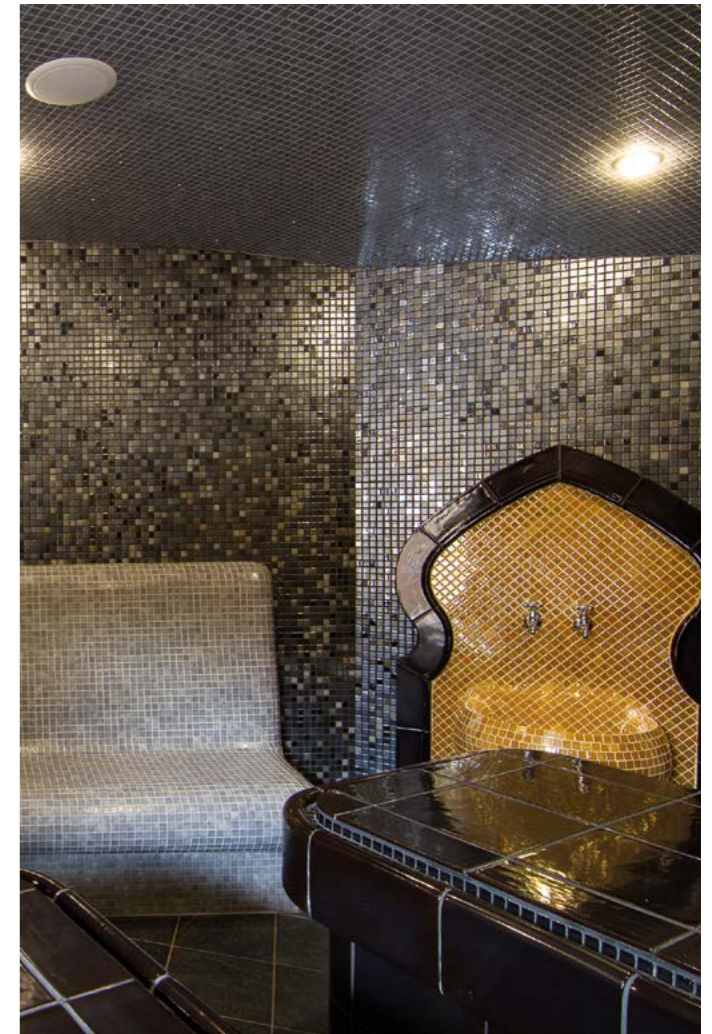

25002-C

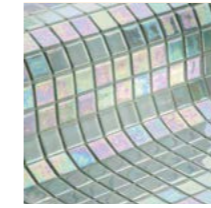

Perla

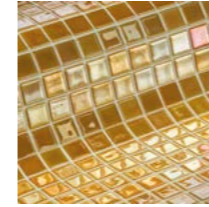

Aurum

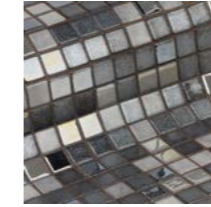

Gin Fizz

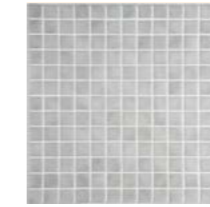

2522-B

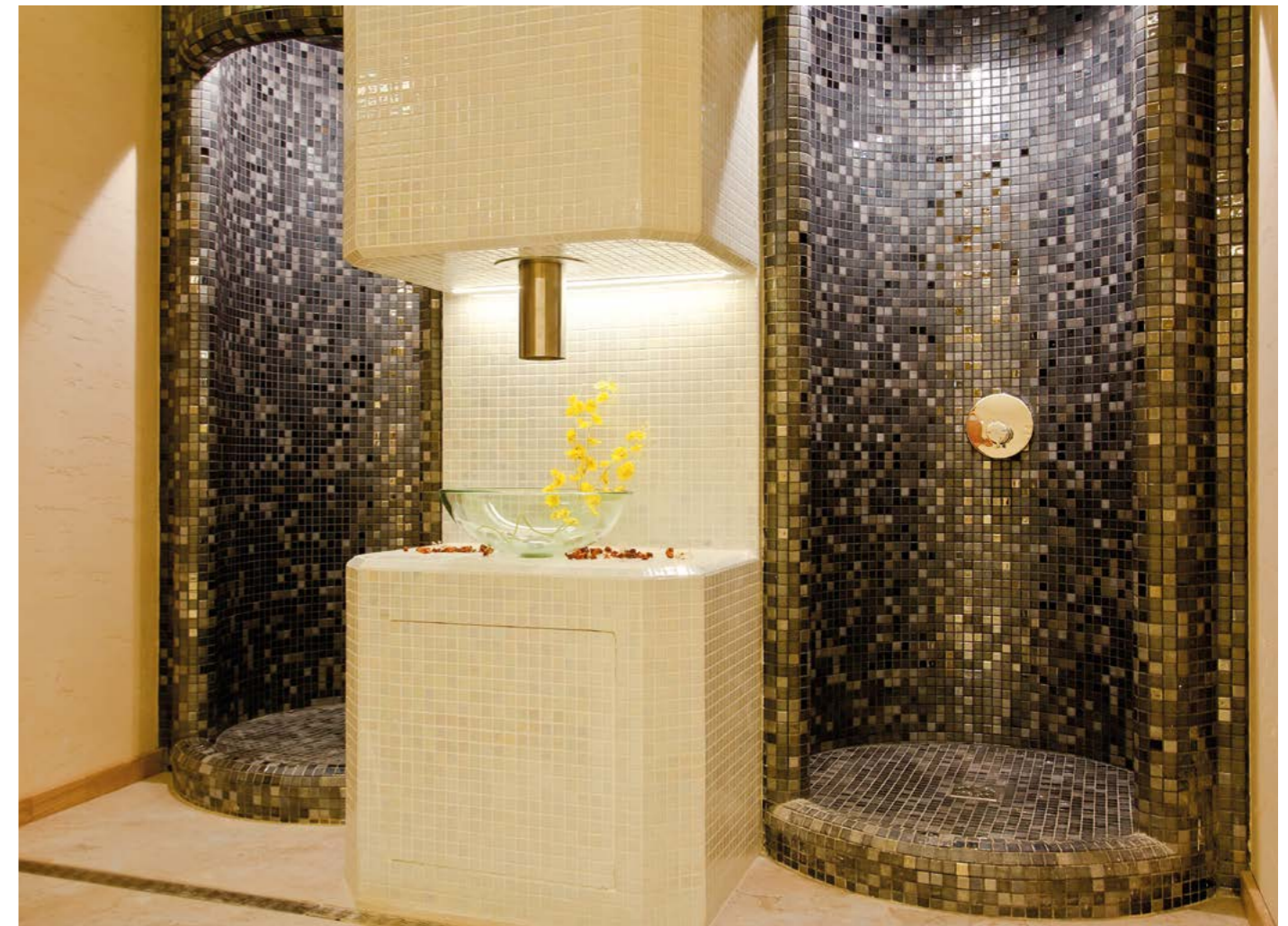

Beau Monde Salon and Spa

LUCKER, UNITED KINGDOM

NEW CONSTRUCTION

Beau Monde meaning "Beautiful world" was most fitting for this intimate yet luxurious, award winning salon and spa set in the heart of the Northumberland countryside. A sanctuary so you can slow down and find a moment of peace at the spa tiled with Lava mosaic (Metal collection).



Lava



Palac Wiechlice Hotel

SZPROTAWA, POLAND

AQUATEC

RENOVATION

The Wellness Zone of the Wiechlice Palace is an indoor swimming pool with an area of 60 square meters tiled with 2545-A mosaic and a sauna zone with a Finnish sauna and a Roman bath.

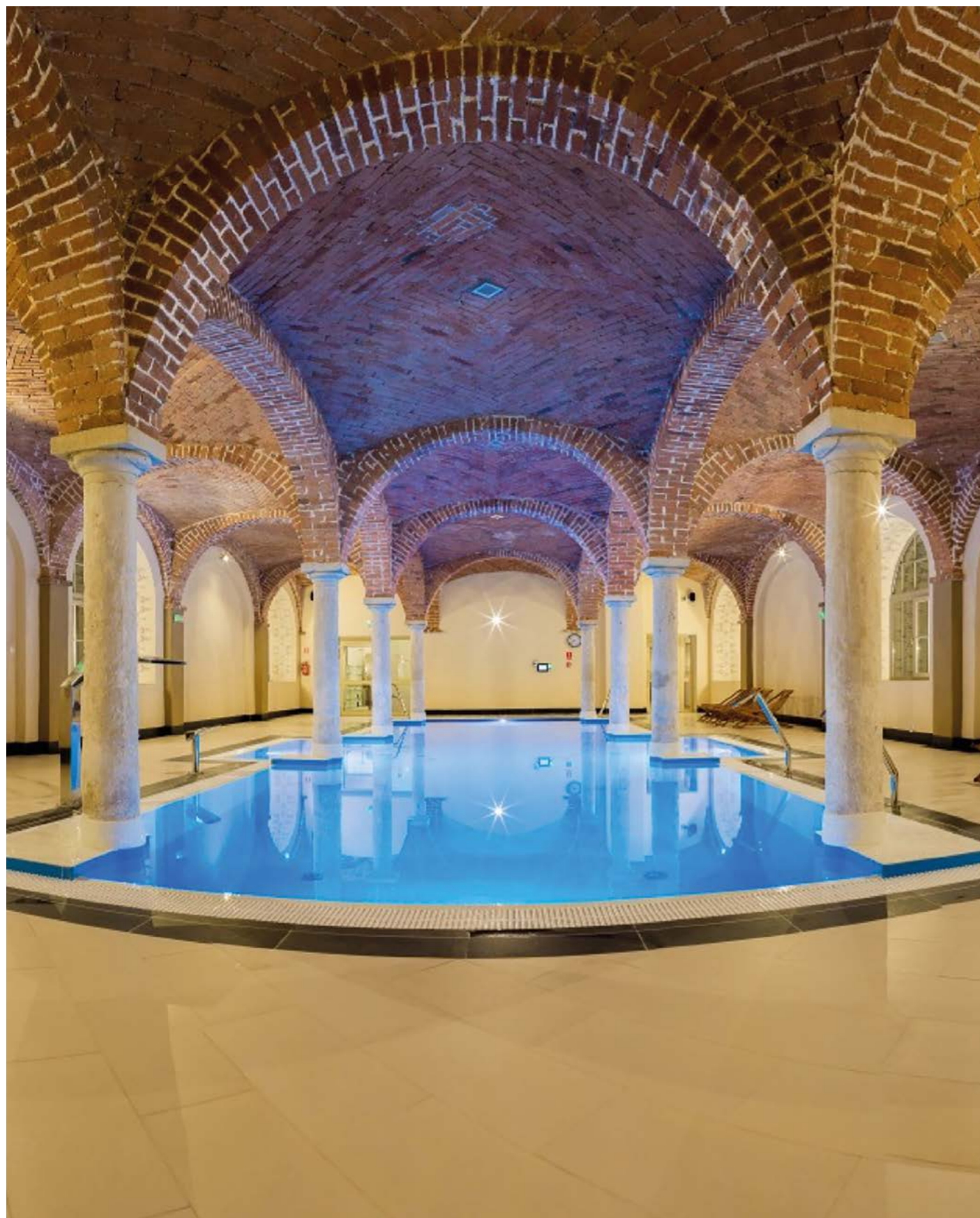

2545-A



Waterside Hotel

DIDSBURY, UNITED KINGDOM

MILK LEISURE ARCHITECTS

RENOVATION



High end glass mosaic to achieve the best relax in thermal suites and hydrotherapy pool.

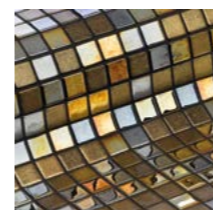

Alexander

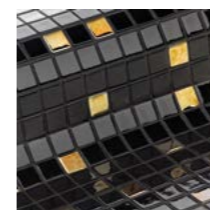

Eclipse

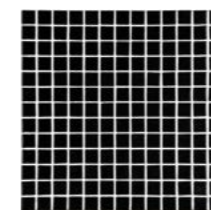

2530-D





More than large

The swimming pool is a place for enjoyment, relaxation, and unwinding. An unique space that can also be the centrepiece of your home. Check out our Pool & Home catalogue to see how Ezarri can help make your home a dream come true.

Discover our complete collection of mosaics, colours, characteristics and materials online at www.ezarri.com.

La piscina es un lugar para el disfrute, el relax, la desconexión. Un espacio único que puede ser también el eje de tu hogar; consulta nuestro catálogo Pool & Home para descubrir cómo Ezarri puede hacer que tus sueños se cumplan en tu propia casa.

Y además, descubre toda nuestra colección de mosaicos, sus colores, características y materiales en nuestra web www.ezarri.com.

La piscine est un lieu de plaisir, de détente, de déconnexion. Un espace unique qui peut aussi être l'axe de votre maison; consultez notre catalogue Pool & Home pour découvrir comment Ezarri peut réaliser vos rêves dans votre propre maison.

De plus, découvrez toute notre collection de mosaïques, leurs couleurs, leurs caractéristiques et les documents sur notre site web www.ezarri.com.

Contact us

Do you want to know more?
ezarri.com

Operadora: (+34) 943 164 140
Comercial España & Portugal: (+34) 943 164 800
Export Sales Agent: (+34) 943 164 801
Commercial France: (+34) 943 164 802

info@ezarri.com

Zubierreka Industrialdea 58
20210 Lazkao (Gipuzkoa) Spain

**Dreams
are made
of mosaics**

ezarri

Operadora: (+34) 943 164 140
Comercial España & Portugal: (+34) 943 164 800
Export Sales Agent: (+34) 943 164 801
Commercial France: (+34) 943 164 802

Discover the complete range at
Descubre las colecciones al completo en
Venez découvrir les collections au complet sur

ezarri.com